



# Fast Analysis of USP 467 Residual Solvents using the Agilent 7890A GC and Low Thermal Mass (LTM) System

## Application Note

Pharmaceutical

### Author

Roger L Firor  
Agilent Technologies, Inc.  
2850 Centerville Road  
Wilmington, DE 19808  
USA

### Abstract

A dual column residual solvent analysis according to USP 467 (2008-09 revision) was performed using the Low Thermal Mass (LTM) system installed on an Agilent 7890A GC system. The G1888 Automated Headspace sampler connected to the volatiles interface was used for sample introduction. A Capillary Flow Technology (CFT) two way splitter was used to split the sample equally to a 5 inch 7 M x 0.25 mm x 1.4  $\mu\text{m}$  Agilent J&W DB-624 column and a 5 inch 7 M x 0.25 mm x 0.25  $\mu\text{m}$  Agilent J&W HP-INNOWax column. Each column module was connected to its own FID by retention gaps. Aqueous solutions of Class 1, Class 2A, and Class 2B solvents were analyzed. Sensitivity, linearity, and resolution met the requirements of USP 467. Overall cycle times for the analysis of all specified Class 1 and Class 2A and 2B solvents were reduced to 10 min.



**Agilent Technologies**

## Introduction

Residual solvents in pharmaceuticals may remain from the manufacturing process of the active pharmaceutical ingredients (API) or final product. The level of residual solvents are monitored and controlled for a number of reasons that include safety, effect on crystalline form, solubility, bioavailability, and stability. All drug substances, excipients, and products are included under USP 467.

The LTM (Low Thermal Mass) chromatographic system is combined with static headspace sampling for the analysis of residual solvents in pharmaceuticals according to USP 467 revised general chapter 2008. [1] This chapter follows guidelines set by the International Conference for Harmonization (ICH) Q3C. [2] Residual solvents are divided into three classes based on possible toxicity. Class 1 solvents are considered the most toxic and should be avoided in manufacture. These solvents may also pose an environmental risk. Class 2 solvents (2A, 2B, and 2C) are less toxic with limited use. Class 2C solvents have higher boiling points and some of them require analysis by non-headspace methods. Class 3 are least toxic and should be used as solvents where practical. Headspace GC is used for determination of Class 1 and Class 2 solvents, while most Class 3 solvents are analyzed by a nonspecific method such as loss on drying. Each Class 2 solvent has a "permitted daily exposure" (PDE) limit. If a given solvent tests below the PDE limit then further testing is not required (daily dose below 10 grams). Option 2 of the general chapter, which looks at the total solvent added for all components of the drug product, is used for daily amounts above 10 g.

This work follows the guidelines of the method with the exception of column dimensions and GC oven programs. Column dimensions and program rates were optimized to gain a significant reduction in analysis time and overall cycle time.

Alternate methodologies such as those described here can be used, however, validation and comparison to the original USP monograph may be required. The FDA also requires that any new ANDA provide the data necessary to prove control of residual solvents prior to a generic drug approval.

USP 467 specifies three procedures as follows for Class 1 and Class 2 residual solvents:

1. Procedure A: Identification and limit test
2. Procedure B: Confirmatory test
3. Procedure C: Quantitative test

Procedure A uses a G43 phase (Agilent J&W DB-624 column in this work) and Procedure B uses a G16 phase (Agilent J&W HP-INNOWax column in this work). In general a particular co-elution that occurs on one of these phases will not occur on the other.

## Experimental

The water soluble procedures were used for standard sample preparation to demonstrate system performance. Insoluble articles require use of DMSO, DMF, or other suitable non-aqueous solvent. The methodology used is very similar for both solvent systems.

A diagram of the dual column system used is shown in Figure 1. The setup splits the effluent from the headspace equally to the J&W DB-624 and J&W HP-INNOWax columns for a simultaneous dual channel analysis. Previous work has been described using conventional oven heating and two-hole ferrules with the split/splitless inlet for dual column residual solvents. [3] Configuration and parameter settings for the LTM system are given in Table 1.

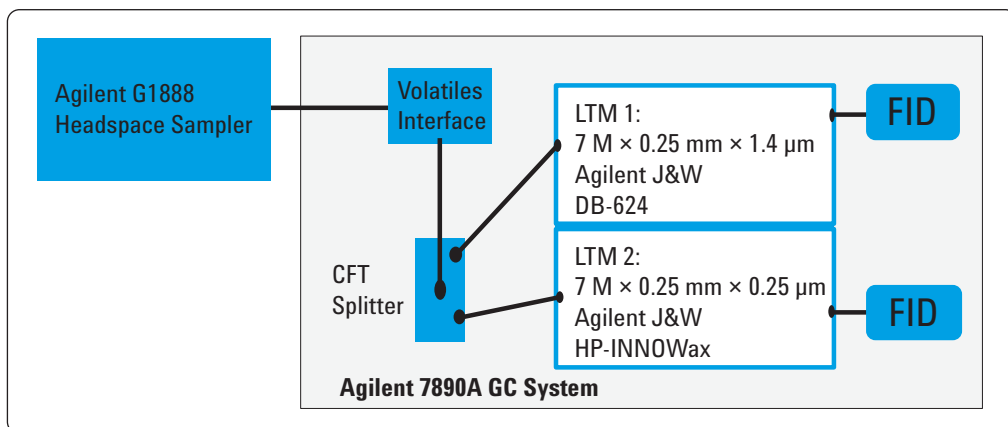

Figure 1. System diagram showing CFT splitter use in dual LTM column configuration.

Table 1. Residual Solvent System Parameters

Standards	
Class 1:	p/n 5190-1566, equivalent to USP Mixture RS
Class 2A:	p/n 5190-0491, equivalent to USP Mixture A RS
Class 2B:	p/n 5190-0492, equivalent to USP Mixture B RS

**Software**

ChemStation:	B.04.02
Headspace:	G2923AA, A.01.06
LTM:	G6586AA

**7890A Configuration and Method Parameters**

Inlet:	Volatiles Interface, 120 °C
Pressure program:	12 psig (4 min) to 22 psig (2 min) at 2.0 psi/min
Split ratio:	14:1, He carrier
Detectors:	Dual FID
CFT:	Two-way splitter, G3181B
7890A oven:	Isothermal at 220 °C
LTM Module 1:	7 M × 0.25 mm × 1.4 µm J&W DB-624
LTM Module 2:	7 M × 0.25 mm × 0.25 µm J&W HP-INNOWax
Module connections to CFT splitter and FID's:	0.5 M × 0.25 mm deactivated retention gap
LTM module programs:	See Table 3.

**G1888A Headspace Parameters**

Oven:	80 °C
Loop:	90 °C
Transfer line:	110 °C
Cycle time:	LTM program dependent
Vial Equilibration time:	60 min
Pressurize time:	0.15 min
Loop fill:	0.15 min
Loop equilibration:	0 min
Inject:	0.50 min
Vials:	10 mL, high shake
Vial pressure:	16.0 psig for 7890A Aux channel

Standard solutions of the Class 1, Class 2A, and Class 2B solvents were prepared in pure water according to the USP 467 procedures shown in Table 2. These stock solutions can be stored for 1 to 2 months at room temperature in a well sealed volumetric. Two grams of sodium sulfate was added to each headspace vial to assist with headspace extraction.

Table 2. Standard Preparation

**Class 1 solvents**

1. 1.0 mL stock solution vial plus 9 mL DMSO diluted to 100 mL
2. 1.0 mL from step 1 diluted to 100 mL with water
3. 10 mL from step 2 diluted to 100 mL with water
4. 1.0 mL step 3 and 5 mL water in 10 mL HS vial

**Class 2A solvents**

1. 1.0 mL stock solution vial, diluted to 100 mL
2. 1.0 mL from step 1 in 5 mL water in 10 mL HS vial

**Class 2B solvents**

1. 1.0 mL stock solution vial, diluted to 100 mL
2. 1.0 mL step 1 in 5 mL water in 10 mL HS vial

Headspace samples were also prepared for the Class 2A solvents at other concentrations ranging from about 10 times below USP limit values to 6 times above to demonstrate linearity. Results are shown in Figure 2. For example, according to USP Procedure A, the limit concentration (in prepared headspace vials) for 1,4 dioxane is 3.17 µg/mL. The concentrations used (µg/mL) for linearity were 0.190, 0.317, 1.90, 3.17, and 19.0 in water.

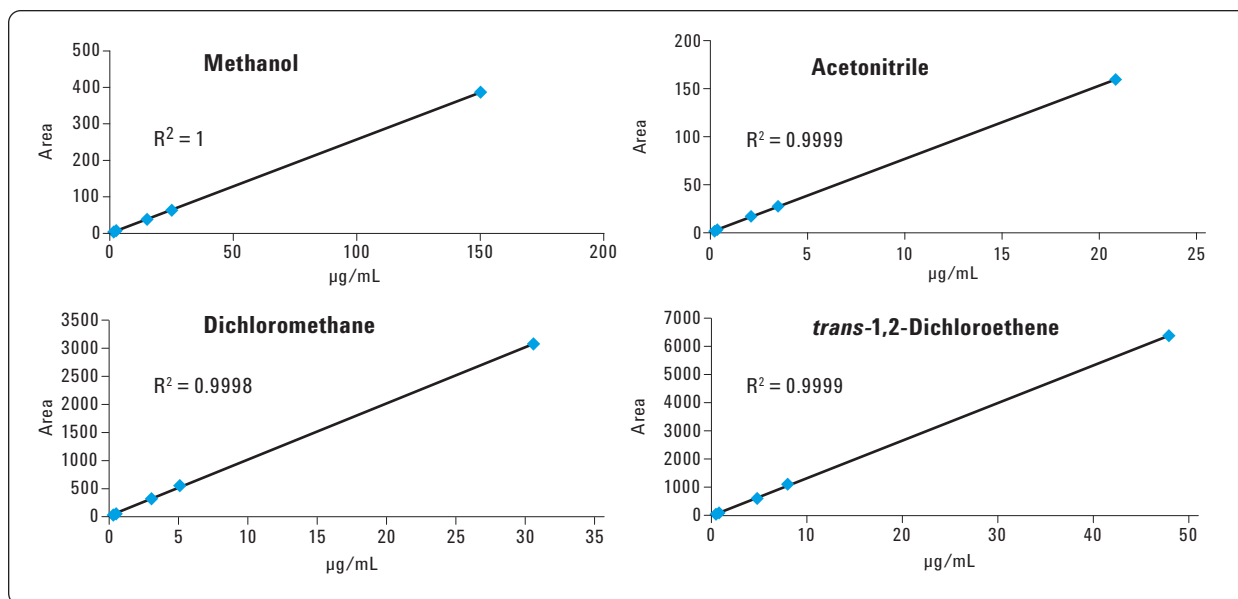

Figure 2. Calibration curves for Class 2A solvents from approximately 10 times below limit values to 6 times above. (Continued)

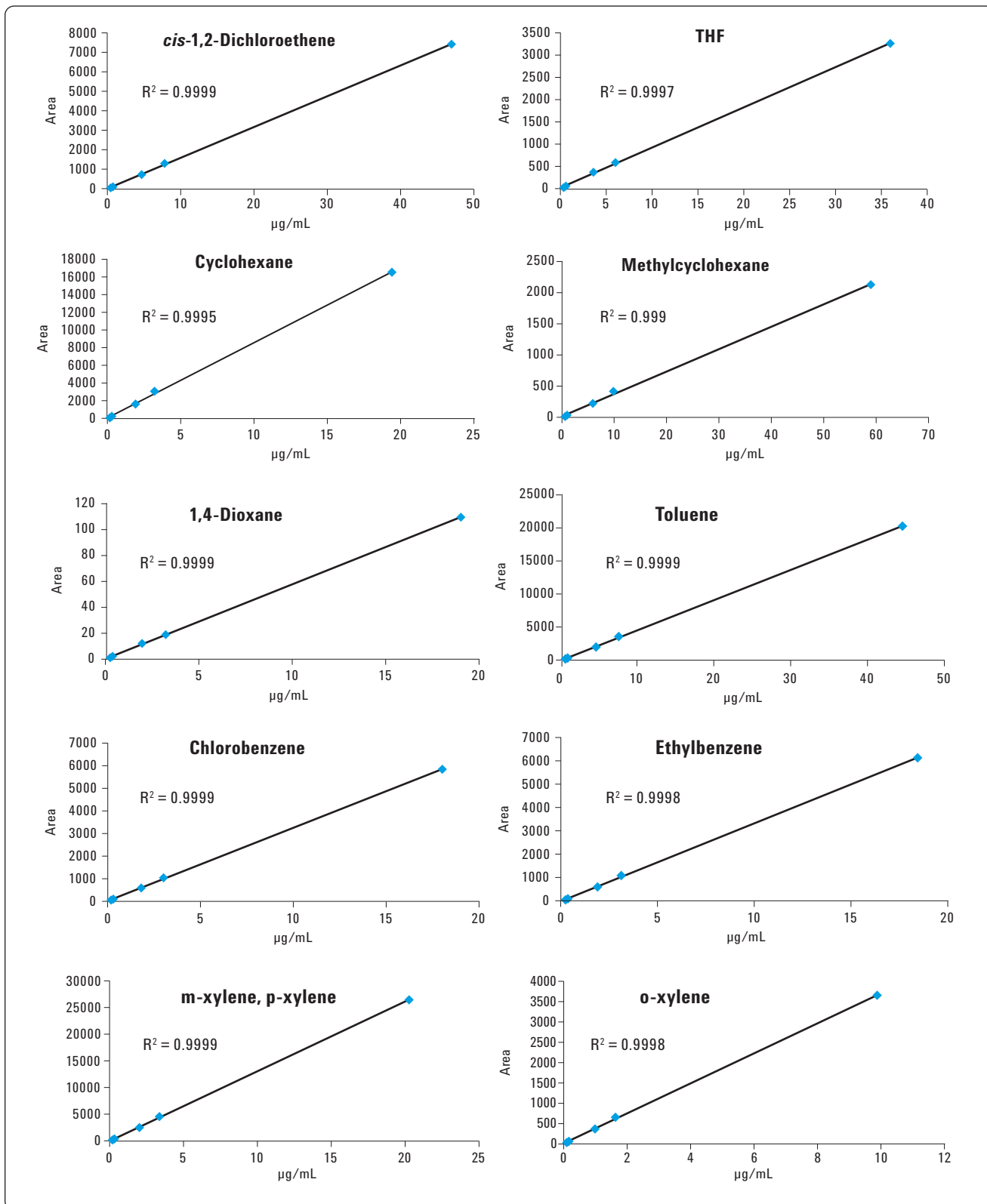

Figure 2. Calibration curves for Class 2A solvents from approximately 10X below limit values to 6X above.

## Discussion

In temperature-programmed gas chromatography, which is required for residual solvent analysis, oven cool down time has a major impact on overall cycle time. LTM column modules cool down at considerably faster rates compared to air bath ovens due to their very low thermal mass and cooling fan configuration directly below the column assembly. LTM columns are also capable of much higher temperature programmed ramp rates, which shorten cycle time further. Maximum practical program rates will depend on a number of factors including column dimensions, phase ratio, carrier gas, and the separation required. When translating a conventional air bath method to the LTM format, Agilent Method Translation software can be used to calculate starting conditions. An example is shown in Figure 3 for translating from a standard 30 M column to a 7 M LTM module. LTM program rates ranging from 60 °C/min to 120 °C/min gave acceptable results in terms of meeting required resolution of specific sol-

vent pairs. Previous work describing the use of LTM technology for a generic set of residual solvents employed a 20 m × 0.18 mm, 1.0 μm J&W DB-624 column. [5]

A comparison of various column dimensions and program rates are shown in Table 3. Air bath and LTM methods are included. The table includes entries for the same column (7 M) dimension in air bath and LTM configurations, which allows a valid comparison of overall cycle time. Note that the maximum air oven program rates possible for the 7890A 120V and 220V GC systems, over the range needed for this application (35 °C to 240 °C), are 30 °C/min and 45 °C/min, respectively. When comparing against a 220V 7890A GC, the LTM still achieves a 50% reduction in cycle time. Throughout this work, both LTM columns were controlled from the LTM ChemStation Software add-on module and operated with identical oven programs. However, the LTM columns can each have unique programs that assist with optimization. The only restraint is that both column programs start at the same time. Ending times may be different

Original Method		Translated Method	
<b>Column</b>			
Length, m	30	<input type="checkbox"/> 7	
Internal Diameter, μm	320	<input type="checkbox"/> 250	
<b>Film</b>			
Thickness, μm	1.80	<input type="radio"/> Unlock	
Phase Ratio	44.44	<input checked="" type="radio"/> 44.44	
<b>Carrier Gas</b>			
Enter one Setpoint		<input type="checkbox"/> Helium	
Head Pressure, psi	16.305		9.399
Flow Rate, mLn/min	4.0000		3.1250
Outlet Velocity, cm/sec	89.06		113.99
Average Velocity, cm/sec	54.95		84.71
Hold-up Time, min	0.909952		0.137719
Outlet Pressure (absolute), psi	14.696	<input type="checkbox"/> 14.696	
Ambient Pressure (absolute), psi	14.696	<input type="checkbox"/> 14.696	
<b>Oven Temperature</b> 1-ramp Program			
	<b>Ramp Rate</b>	<b>Final Temp.</b>	<b>Final Time</b>
	°C/min	°C	min
Initial			
Ramp 1	10.000	40	20
	66.073	250	3.027
<b>Sample Information</b> None			

Figure 3. Method translation from standard 30 M column to an Agilent J&W DB-624 7 M LTM column. See [www.agilent.com/chem/methodtranslator](http://www.agilent.com/chem/methodtranslator) to download this tool.

Table 3. Cycle Times for Various Column and Oven Type Configurations

Heating	Column	Program	Cool down	Cycle time
7890A (120V)	30 M × 0.53 mm × 3.0 μm Agilent J&W DB-624	40 °C (20 min) to 240 °C (20 min) at 10 °C/min	6 min 50 sec with 3 min oven equil.	67 min
7890A (120)	7 M × 0.25 mm × 1.4 μm Agilent J&W DB-624	35 °C (5 min) to 240 °C (5 min) at 30 °C/min*	8 min 25 sec with 3 min oven equil.	25 min 15 sec
7890A (220)	7 M × 0.25 mm × 1.4 μm Agilent J&W DB-624	35 °C (5 min) to 240 °C (5 min) at 30 °C/min**	8 min 25 sec with 3 min oven equil.	22 min 30.sec
LTM (Fast)	7 M × 0.25 mm × 1.4 μm Agilent J&W DB-624	35 °C (5 min) to 240 °C (5 min) at 30 °C/min	1 min 45 sec (one module system)	15 min 10 sec
LTM (Faster)	7 M × 0.25 mm × 1.4 μm Agilent J&W DB-624	35 °C (5 min) to 240 °C (3 min) at 100 °C/min	1 min 45 sec (one module system)	11 min 45 sec
LTM (Fastest)	7 M × 0.25 mm × 1.4 μm Agilent J&W DB-624	35 °C (4 min) to 240 °C (3 min) at 120 °C/min	1 min 45 sec (one module system)	10 min 30 sec

LTM chromatograms of Class 1 solvents are shown in Figures 4A and 4B on Agilent J&W DB-624 and J&W HP-INNOWax modules, respectively. Resolution between two Class 2A solvents (acetonitrile and methylene chloride on J&W DB-624 columns) meets method requirements as shown in Figure 5. Signal-to-noise ratio's for all Class 1 solvents are greater than 3 at specified limit concentrations.

Chromatograms for Class 2A and 2B solvents on both J&W DB-624 and J&W HP-INNOWax phases are shown in Figures 6 and 7. All Class 1, 2A, and 2B solvents combined at limit

concentrations are shown in Figure 8. Peak identifications and limit concentrations in prepared headspace vials are shown in Table 4. Note that operating at 120 °C/min yields a cycle time of 10.5 minutes.

Headspace vial equilibration times were kept at 60 min in this work, following USP 467. However, it should be noted that equivalent results can be obtained with 30 min heating times [3]. Additional benefits in sensitivity and repeatability are possible using electronic back pressure control of the headspace vial venting (loop fill) process. This is discussed at length in Application Note 5989-6079EN [6].

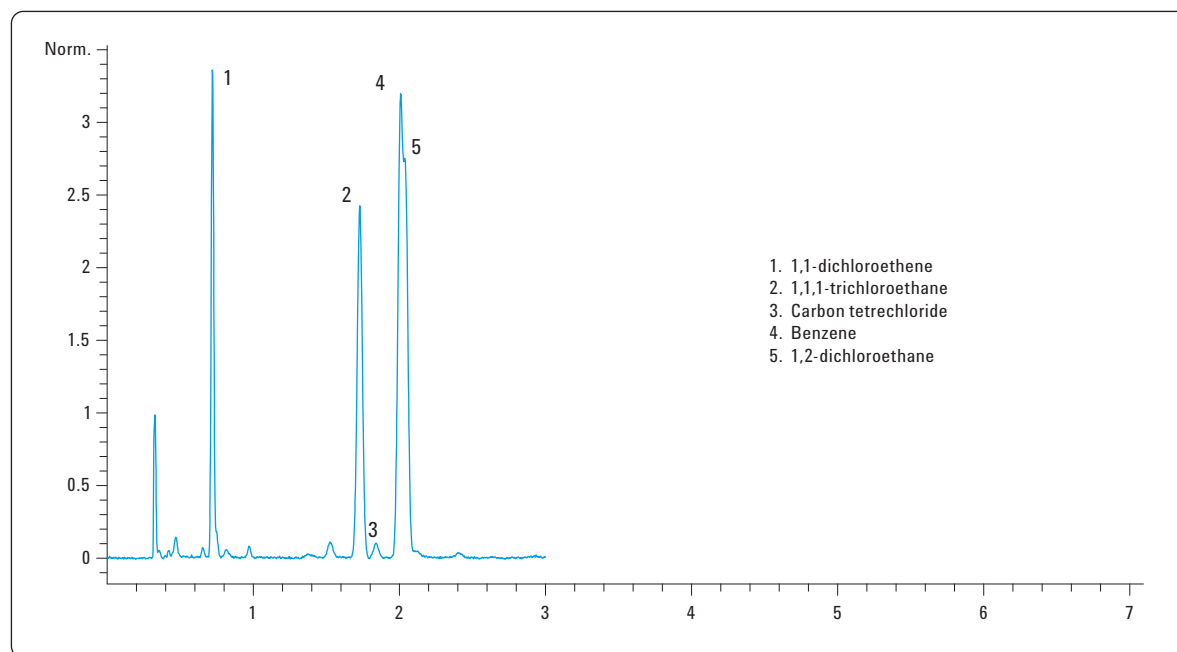

Figure 4A. Class 1 residual solvents at limit concentration on an Agilent J&W DB-624 column at 60 °C/min program rate.

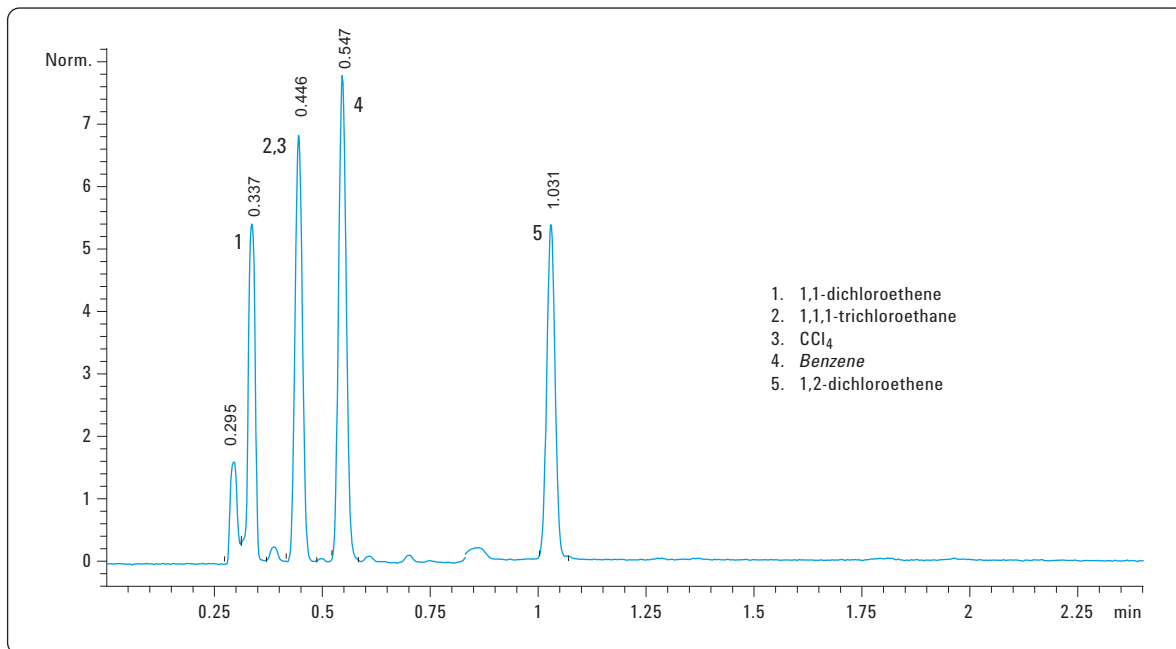

Figure 4B. Class 1 residual solvents at limit concentration on an Agilent J&W HP-INNOWax column at 60 °C/min.

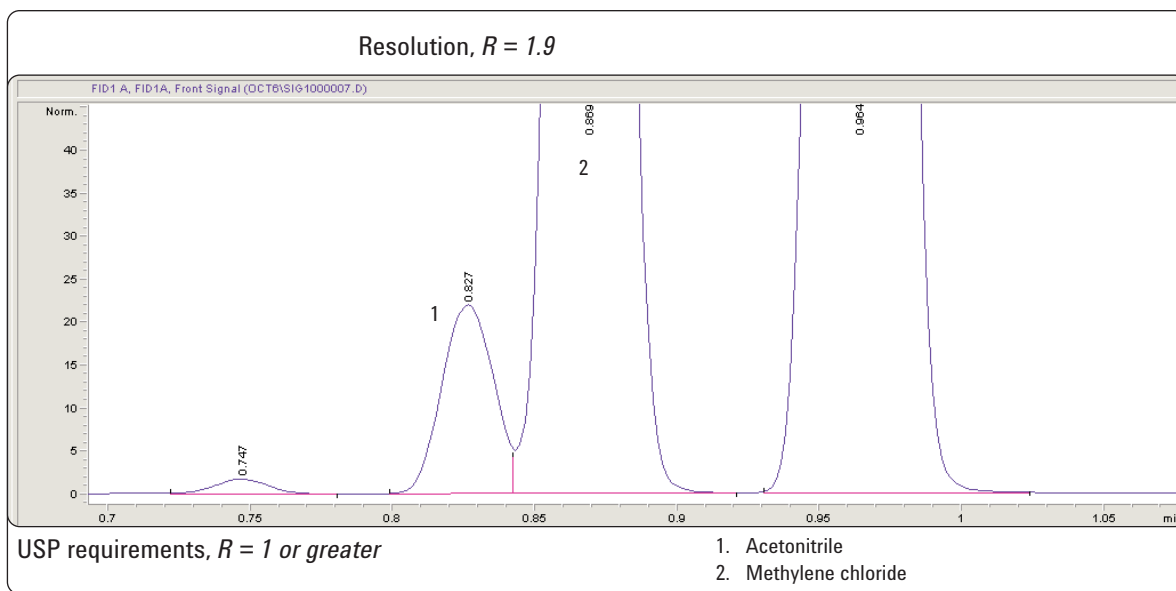

Figure 5. Acetonitrile/methylene chloride resolution.

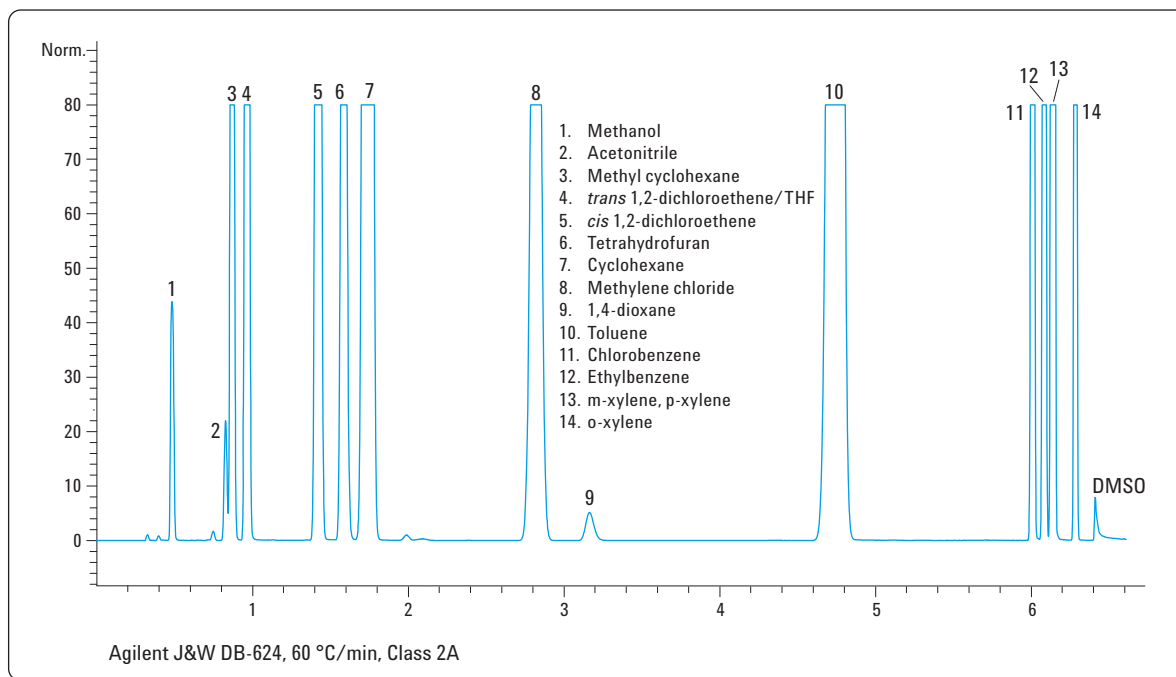

Figure 6A. Class 2A solvents at limit concentration on an Agilent J&W DB-624 column, 60 °C/min.

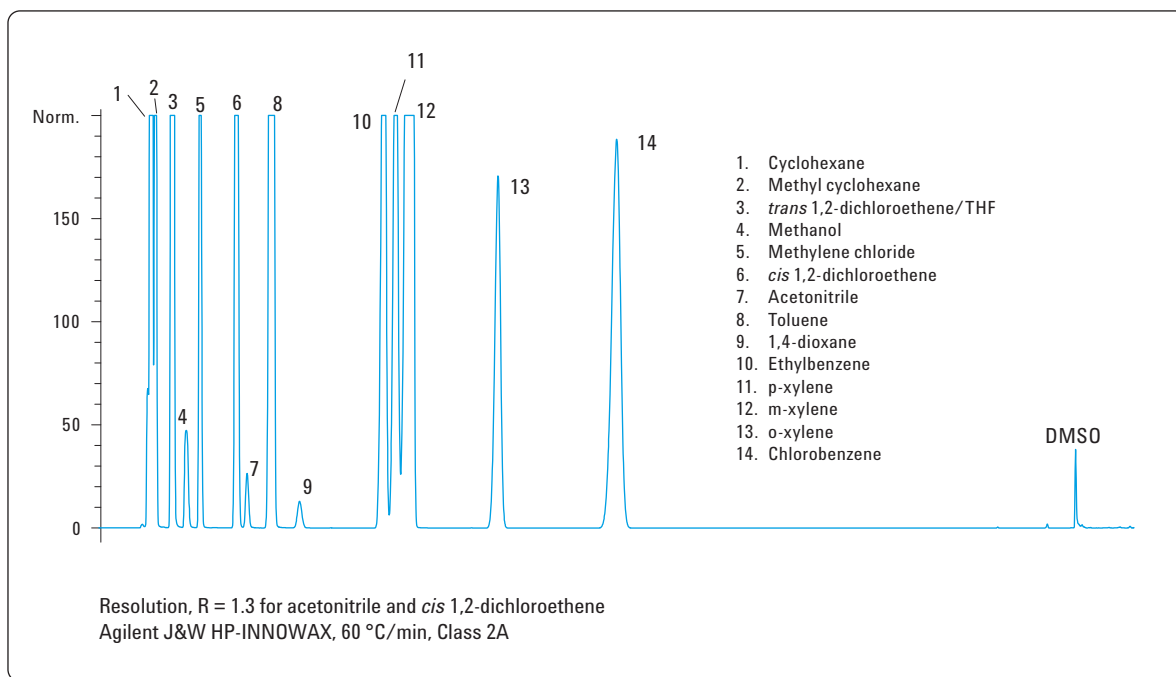

Figure 6B. Class 2A solvents at limit concentration on an Agilent J&W HP-INNOWax column, 60 °C/min.



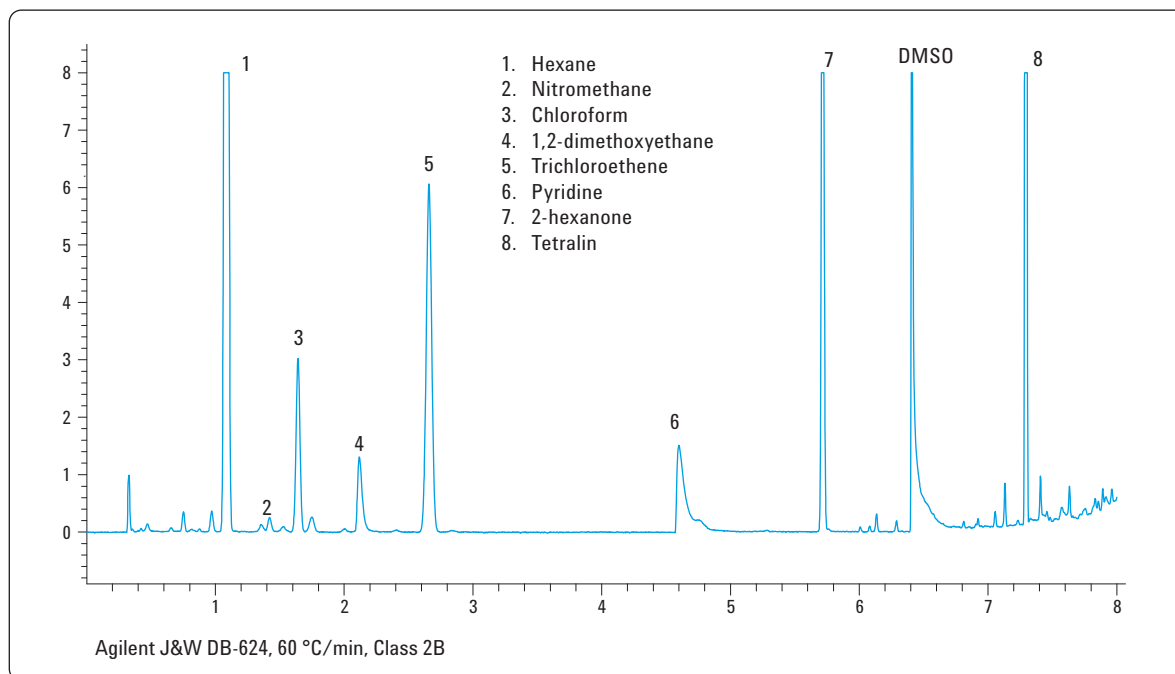

Figure 7A. Class 2B solvents at limit concentration on Agilent J&W DB-624 column, 60 °C/min

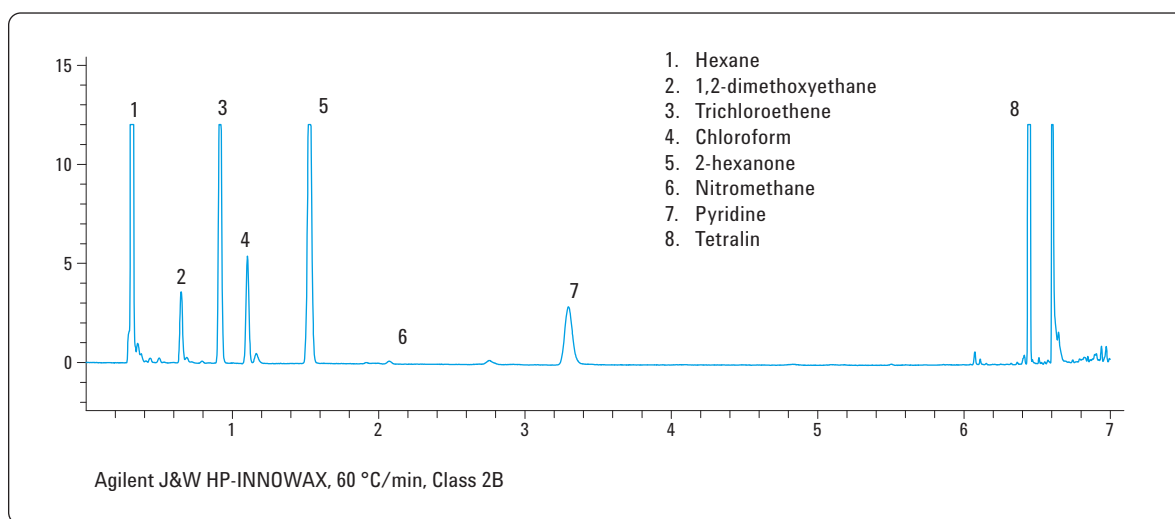

Figure 7B. Class 2B solvents at limit concentration on Agilent J&W HP-INNOWax column, 60 °C/min.

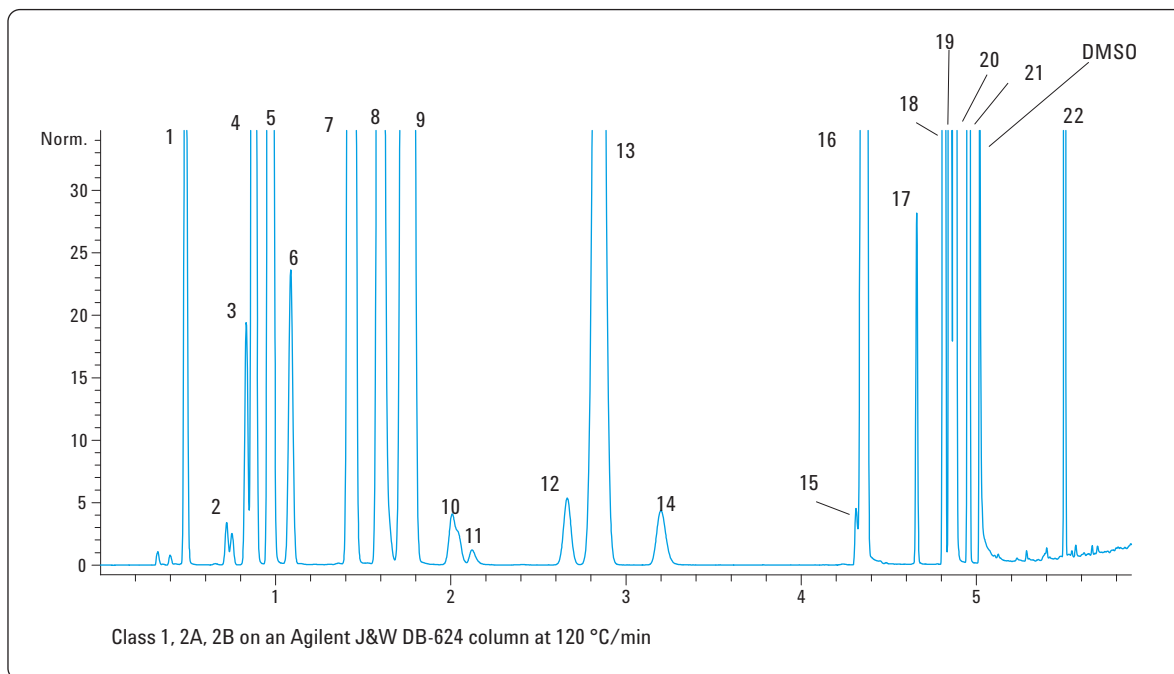

Figure 8. Class 1, 2A, and 2B solvents at limit concentration on Agilent J&W DB-624 column, 120 °C/min. Peak IDs in Table 4.

Table 4. Peak Numbering for Figure 8 and Actual Headspace Vial Concentrations

Class 1	Conc (µg/mL)	Class 2A	Conc (µg/mL)	Class B	Conc (µg/mL)
2. 1,1-dichloroethene	66.7	1. Methanol	25.0	6. Hexane	0.483
9. 1,1,1-trichloroethane	83.3	3. Acetonitrile	3.41	7. Nitromethane	0.083
9. Carbon tetrachloride	33.3	4. Methylene chloride	5.00	8. Chloroform	0.100
10. 1,2-dichloroethane	41.7	5. <i>trans</i> -1,2-dichloroethene	7.83	11. 1,2-dimethoxyethane	0.167
10. Benzene	16.7	7. <i>cis</i> -1,2-dichloroethene	7.83	12. Trichloroethene	0.133
		8. Tetrahydrofuran	6.00	15. Pyridine	0.333
		9. Cyclohexane	3.23	17. 2-hexanone	0.083
		13. Methylcyclohexane	9.83	22. Tetralin	0.167
		14. 1,4-dioxane	3.17		
		16. Toluene	7.42		
		18. Chlorobenzene	3.00		
		19. Ethylbenzene	3.07		
		20. <i>m, p</i> -xylene	3.38		
		21. <i>o</i> -xylene	1.63		

**Coelutions on DB-624**

- *cis*-1,2-dichloroethene, nitromethane
- THF, chloroform
- Cyclohexane, CCl<sub>4</sub>, 1,1,1-trichloroethane
- Benzene, 1,2-dichloroethane

## Conclusions

A 6X overall reduction in cycle time is possible when converting from the standard methodology to a LTM based system for residual solvent analysis. Capillary flow technology can be employed to conveniently analyze on two column phases (Agilent J&W DB-624 and Agilent J&W HP-INNOWax columns) simultaneously from a single headspace injection. LTM column dimensions of 7M x 0.25 mm provide a good compromise among speed, ease-of-use, and capacity while meeting the resolution requirements of USP 467. This general methodology using LTM technology should be particularly attractive to new drug development where variations to the USP procedures are appropriate and fast method optimization is desired.

The Chemstation method integrates Agilent 7890A GC/Agilent G1888A Headspace, and LTM control through add-on software modules for ease of setup, operation, method integration, and compliance.

## References

1. USP 32-NF 27, General Chapter USP <467> Organic Volatile Impurities, United States Pharmacopeia. Pharmacopoeia Convention Inc., Rockville, MD, 8/2009.
2. International Conference on Harmonization (ICH) of Technical Requirements for the Registration of Pharmaceuticals for Human Use, Q3C (R4): Impurities guideline for residual solvents, Step 4, July 1997.
3. Joseph M. Levy and Michael Kraft, "Simultaneous Dual Capillary Column Headspace GC With Flame Ionization Confirmation and Quantification According to <USP467>," Agilent Technologies publication 5989-8085EN, 2008.
4. Frank David, Roman Szucs, Jay Makwans, and Pat Sandra, "Fast Capillary GC using a Low Thermal Mass Column Oven for the Determination of Residual Solvents in Pharmaceuticals," Pfizer Analytical Research Centre, Ghent University, Krijgslann, Ghent, Belgium, J. Sep. Sci. 2006, 29, 695-698, 2006.
5. Roger L. Firor, "The Determination of Residual Solvents in Pharmaceuticals Using the Agilent G1888 Network Headspace Sampler," Agilent Technologies publication 5989-1263EN, 2004.
6. Albert E. Gudat and Roger L. Firor, "Improved Retention Time, Area Repeatability, and Sensitivity for Analysis of Residual Solvents," Agilent Technologies publication 5989-6079EN, 2007.

## For More Information

For more information on our products and services, visit our Web site at [www.agilent.com/chem](http://www.agilent.com/chem).

[www.agilent.com/chem](http://www.agilent.com/chem)

Agilent shall not be liable for errors contained herein or for incidental or consequential damages in connection with the furnishing, performance, or use of this material.

Information, descriptions, and specifications in this publication are subject to change without notice.

© Agilent Technologies, Inc., 2010  
Printed in the USA  
January 26, 2010  
5990-5094EN



**Agilent Technologies**