

JENWAY

Equipment for Analysis

Double Beam Spectrophotometers

Life Science Spectrophotometers

UV/Visible Spectrophotometers

pH Meters

Ion Meters

Flame Photometers

Fluorimeters

Dissolved Oxygen Meters

Conductivity Meters

Colourimeters



Bibby Scientific Limited

Some of the most famous names in science...

Bibby Scientific

As one of the largest broad based manufacturers of benchtop laboratory equipment worldwide, Bibby Scientific Ltd provides internationally recognised brands with reputations for product quality and high performance. These four famous brands are now brought together in a single package to offer an excellent level of quality, service and support.

 **Electrothermal**
A Bibby Scientific Company

Electrothermal are the newest addition to the Bibby Scientific portfolio and are market leaders in heating mantle design and manufacture. The extensive Electrothermal range includes controlled, stirring, Bunsen and spill-proof mantles in various shapes and capacities. Alongside the heating mantle range, Electrothermal offer an extensive selection of stirrers and melting point apparatus.

JENWAY

Jenway® manufactures a wide range of analytical scientific instruments including UV/Vis spectrophotometers, flame photometers, colorimeters, portable and laboratory meters for the measurement of dissolved oxygen, pH, conductivity and specific ions.

 **stuart**®

The extensive Stuart® range includes blood tube rotators, colony counters, hotplates, hybridisation ovens, rockers, shakers, stirrers and water purification systems.

 **TECHNE**

Techne® is a world leader in the manufacture of temperature control equipment, including water baths, Dri-Block® heaters, and molecular biology products such as hybridisation incubators and thermal cyclers.

<http://www.bibby-scientific.com/>



Contents

Equipment for Analysis

i	Introduction to Bibby Scientific
ii	Contents
iii	Jenway Equipment
5	Colourimeters
9	Conductivity Meters
19	Dissolved Oxygen Meters
25	Flame Photometers
29	Fluorimeters
35	Ion Meters
41	pH Meters
57	Spectrophotometers
89	Technical Information
94	Voltage Variants
97	Index by Name
100	Index by Part Code

Find out more! Please scan the QR/Mobile Tag with your smartphone for more information



Welcome to Jenway

Equipment for Analysis

Welcome to the 2nd Edition of the Jenway analytical equipment catalogue. Jenway offers an extensive range of analytical instrumentation such as UV/visible spectrophotometers, flame photometers, colorimeters and electrochemistry products for the measurement of pH, conductivity, dissolved oxygen and specific ions. In this catalogue we are very proud to introduce several new spectrophotometers to the Jenway range:

- New 73 series spectrophotometers – entry-level spectrophotometers which have an improved navigation system and icon driven software for easy and intuitive usability.
- The new Genova Plus and Genova Nano life science spectrophotometers based on the successful 73 series these models introduce improved functionality, absorbance and purity scanning across the whole wavelength range. As well as the ability to pipette the sample directly onto the read head.
- New variable double beam spectrophotometer, model 6850 – building on the success of Jenway's first true double beam, model 6800, this model introduces a variable spectral bandwidth providing improved resolution.

Each section of this catalogue contains a summary page to aid selection of the appropriate instrument to meet your needs. There is also a frequently asked questions section at the back of the catalogue to further aid selection. Alternatively visit www.jenway.com/product-selector.asp and use our handy product selector tool. At Bibby Scientific HQ we also have a technical support team available to offer technical and application advice on the entire Jenway product range. They can be contacted via email on jenwayhelp@bibby-scientific.com.

Please visit www.jenway.com to download instruction manuals, software updates, declarations of conformity and MSDS. The website contains up-to-date product information as well as product videos and information on news, events and exhibitions. All Jenway products are designed, manufactured and marketed in an ISO9001:2008 environment and every step from new product development to after sales service follows documented and traceable procedures. You can find copies of our ISO certificate on www.jenway.com.

All electrical products produced by Bibby Scientific conform to the latest safety directives including the European CE requirements. For total compliance all products are tested and approved by a fully accredited external test house. Bibby Scientific is also compliant with the Waste Electrical and Electronic Equipment Directive (WEEE) and the Restrictions of the use of Certain Hazardous Substances (RoHS).

The products featured in this catalogue are available through a wide range of national and international distributors. For your local distributor details please visit www.jenway.com/wheremap.asp. Our aim is to provide the very best in electrochemistry and spectroscopy instrumentation as well as the highest level of service before, during and after the sale.

The JENWAY logo is displayed in a white, serif font against a dark blue background. The letters 'J' and 'W' are notably larger than the others. A thin red horizontal line is positioned directly beneath the text.

JENWAY

Colorimeters

Equipment for Analysis

The Jenway colorimeter is ideal for routine basic colour measurements across the visible range of wavelengths from 400 to 710nm. The easy-to-use controls also makes the colorimeter suitable for use in education.

Page 6 Bench Colorimeter

Page 7 Accessories

Find out more! Please scan the QR/Mobile Tag with your smartphone for more information



6051

Colorimeter

The 6051 is a general purpose colorimeter, equipped with easy-to-use conventional style controls, making it ideal for routine and educational use.

Standard 10mm square cuvettes, semi-micro volume cuvettes, flow-through or pour in/suck out cells can all be used with the standard sample holder. Excellent sampling flexibility is achieved through the optional cell holder assemblies, allowing the use of 10, 20, and 40mm cells, whilst multiple sample handling is possible with the four cell carriage. For temperature-dependent measurements a heated cell block is available.

Technical Specification

Wavelength range	400 to 710nm
Wavelength selection	8 in-built gelatin filters: 430, 470, 490, 520, 540, 580, 600 and 710nm
Measurement ranges	0-100%T 0-1.50Abs 0.1 to 1000 Conc
Resolution	1%T, 0.01Abs, 0.1 to 1 Conc
Bandwidth	Typically 40nm
Blank drift	2%/hr after 15 minute warm-up
Photometric linearity	1%T
Light source	Tungsten filament lamp
Output	Analogue, 10mV per digit
Power	230V, 50Hz*
Size (l x w x d), mm	300 x 355 x 120
Weight, kg	3

Key Features

- Wide wavelength range from 400 to 710nm
- Ideal for routine and educational use
- Easy to use and conventional style controls
- Sample flexibility with many size options
- Mains or battery operated



6051

Part code: 605 001

Ordering Information

Part Code	Description
605 001	6051 colorimeter supplied with 8 built in filters, 10x10mm cell holder, mains leads and plastic cuvettes (230V/50Hz)

* Voltage variants available see page 94

Ordering Information

Part Code	Description
605 003	10 x 10mm cell holder
606 017	405nm interference filter, 10nm bandwidth
606 018	540nm interference filter, 10nm bandwidth

Cells and Cuvettes

Ordering Information

Part Code	Description
035 027	10 x 10mm glass cell
035 086	10 x 20mm glass cell
035 029	10 x 40mm glass cell
060 084	10 x 10mm 3ml plastic cuvettes (pack 100)
060 087	10 x 10mm 1.5ml plastic cuvettes (pack 100)
060 422	Moulded cuvette rack for 16 10x10mm cuvettes
605 064	Tungsten filament lamp



Cuvettes

(Left to Right)

Part code: 035 086, 035 029, 035 072

Four Brands One Name Hundreds of Products

Bibby Scientific Ltd is one of the largest broad based manufacturers of laboratory products worldwide. Bibby Scientific Ltd provides internationally recognised brands with reputations for product quality and exceptional performance. These famous brands are now brought together in a single package to offer an excellent level of quality, service and support.



Stuart® Benchtop Science Equipment



Jenway® Equipment for Analysis



Techne® Equipment for the Life Sciences



Electrothermal® Equipment for Cooling, Stirring and Heating



Find out more!!!

Please scan the QR/Mobile Tag with your smartphone for more information

Bibby Scientific





JENWAY

Conductivity Meters

Equipment for Analysis

The Jenway range of conductivity meters encompasses five models ranging from basic portable meters, right through to advanced combined pH and conductivity laboratory meters. All the Jenway meters, even the basic ones have automatic standard recognition to ensure the accuracy of results. Additional modes of analysis such as salinity and resistivity are available on selected models and many support GLP by providing date stamped and downloadable results.

Page 10	Conductivity Meter Options
Page 11	Portable Conductivity/TDS Meter
Page 12	Bench Conductivity/TDS Meters
Page 14	Combined Conductivity and pH Meters
Page 16	Accessories and Consumables

Find out more! Please scan the QR/Mobile Tag with your smartphone for more information



Conductivity Meters Options

Select the best Conductivity Meter for you

	470	4510	4520
Type	Portable	Bench	Bench
Conductivity range	0 to 1999mS	0 to 1999mS	0 to 19.99S
Temperature	✓	✓	✓
Temperature units	°C/°F	°C/°F	°C/°F
TDS	✓	✓	✓
Salinity	✓	-	✓
Resistivity	✓	-	✓
No. results stored	32	32	500
GLP support	-	-	✓
Pure water mode	-	-	✓
Outputs	-	Analogue RS232	Analogue RS232 IrDA



Combined Conductivity and pH Meters Options

Select the best Combined Conductivity and pH Meter for you

	430	3540
Type	Portable	Bench
Conductivity range	0 to 199.9mS	0.01µS to 1.999S
Temperature	✓	✓
Temperature units	°C/°F	°C/°F
TDS	✓	✓
Salinity	-	✓
Resistivity	-	✓
mV	-	✓
pH range	0.00 to 14.00	-2.000 to 20.000
Results storage	-	250 in each mode
GLP support	-	✓
Pure water mode	-	✓
Outputs	-	Analogue RS232

- Portable conductivity and TDS meter
- Automatic range selection for optimum resolution
- Automatic or manual calibration
- Storage of up to 32 readings
- 500 hours battery life



470

Part code: 470 271

Enterprise Conductivity/TDS Meter

The 470 hand held conductivity/TDS meter allows calibration by direct cell constant entry or through the use of standard solutions. The display simultaneously shows temperature compensated conductivity or TDS and temperature. For optimum resolution the best conductivity/TDS range is automatically selected, whilst temperature compensation is achieved using an adjustable temperature coefficient.

Technical Specification

Conductivity

Range	6 auto-selected from 0 to 1999mS*
Resolution	0.01µS to 1mS*
Accuracy	±0.5% ±2 digits
Cell constant	0.01 to 19.99
Auto standard recognition	10µS, 84µS, 1413µS, 12.88mS

TDS

Range	6 auto selected from 0 to 1999g/l*
Resolution	0.01mg/l to 1g/l*
Accuracy	±0.5% ±2 digits
EC ratio	0.50 to 0.80

Temperature

Range	-10 to 105°C
Resolution	0.1°C
Accuracy	±0.5°C
ATC and manual	0 to 100°C
Temperature coefficient	0.00 to 4.00%/°C
Reference temperature	18, 20, 25°C
Connector	Mini DIN
Power	2AA batteries
Size (l x w x d), mm	175 x 75 x 35
Weight, g	250

Ordering Information

Part Code	Description
470 271	470 conductivity meter supplied with epoxy conductivity cell K=1 (027 298), batteries (fitted) and free carry case

*With K=5 cell

4510

Bench Conductivity/TDS Meter

The 4510 is easy to use but with the flexibility to meet the broadest range of applications and for those where greater accuracy is required the 4510 has automatic conductivity standard recognition and endpoint detection. Set-up options include cell constant, temperature coefficient and reference temperature. The instrument can store up to 32 readings, which can also be sent to a printer or transferred to computer via DataWay and the RS232 interface.

Technical Specification

Conductivity

Range	6 auto-selected from 0 to 19999mS*
Resolution	0.01µS to 1mS
Accuracy	±0.5% ±2 digits
Automatic std. recognition	10µS, 84µS, 1413µS, 12.88mS
Cell constant	0.010 to 19.999

TDS

Range	6 auto-select from 0-19999g/l*
Resolution	0.01mg/l to 1g/l
Accuracy	±0.5% ±2 digits
EC Ratio	0.50 to 0.80

Temperature

Range	-10 to 105°C
Resolution	0.1°C
Accuracy	±0.5°C
ATC and manual	0 to 100°C
Temperature coefficient	0.00% to 4.00%/°C
Reference temperature	18, 20 or 25°C
Outputs	Analogue and RS232
Connector	7-pin DIN
Power	9V AC ±10% @ 50/60Hz**
Size (l x w x d), mm	210 x 250 x 55
Weight, g	850

Key Features

- Simultaneous display of conductivity or TDS and temperature
- Automatic selection of range for best resolution
- Calibration by cell constant or standard solutions
- Automatic standard recognition
- Storage of up to 32 results
- Bi-directional RS232 link to printer or PC



4510

Part code: 451 001

Ordering Information

Part Code	Description
451 001	4510 conductivity meter supplied with glass conductivity probe with ATC (K=1) (027 013), electrode holder (903 300) and UK power supply (021 030)

*With K=10 cell

** Voltage variants available see page 94



Key Features

- Conductivity, resistivity, TDS and salinity modes
- Special pure water mode for ultra low conductivity measurements
- Storage of 500 results with built in data logger
- Infra-red data link (IrDA) for connection to printer and RS232 link to connect to printer or PC via DataWay software



4520

Part code: 452 001

4520

Bench Conductivity/TDS Meter

The 4520 is a high specification laboratory conductivity/resistivity/TDS/salinity and temperature meter that offers additional accuracy with 1, 2 or 3 point conductivity calibration across the wide measurement range of 0 to 19.995. The dedicated 'pure water' mode ensures the optimum accuracy for this difficult application.

Technical Specification

Conductivity

Range	6 auto-selected from 0 to 19.995*
Resolution	0.01µS -0.01S
Accuracy	±0.5% ±2 digits
Automatic std. recognition	10µS, 84µS, 1413µS, 12.88mS
Cell constant	0.010 to 19.999

TDS

Range	6 auto selected ranges 0-1999g/l*
Resolution	0.01mg/l -1g/l
Accuracy	±0.5% ±2 digits
EC ratio	0.50 to 0.80

Resistivity

Range	0-20Mohm
Resolution	0.01Mohm
Accuracy	±0.5% ±2 digits

Salinity

Range	0-99.9g/l
Resolution	0.1g/l
Accuracy	0-35 ±1g/l, 35-99.9 ±3g/l

Temperature

Range	-10 to 105°C
Resolution	0.1°C
Accuracy	±0.5°C
ATC and manual	0 to 100°C
Temperature coefficient	0.00% to 4.00%/°C
Reference temperature	18, 20 or 25°C
GLP	Calibration reminder interval, alarm outputs and security code protected data
Outputs	Analogue, RS232 and IrDA interface
Connector	7-pin DIN
Power	9V AC ±10% @ 50/60Hz**
Size (l x w x d), mm	210 x 250 x 55
Weight, g	850

*With K=10 cell

** Voltage variants available see page 94

Ordering Information

Part Code	Description
452 001	4520 conductivity meter supplied with glass conductivity probe with ATC (K=1) (027 013), electrode holder (903 300) and UK power supply (021 030)

430

Enterprise Conductivity/pH Meter

The easy to use 430 is designed to readily withstand the rigours of field work, while reliably measuring pH and conductivity. The unit allows the simultaneous readout of pH, conductivity or TDS and temperature with switched ranges for both conductivity and TDS measurements.

Technical Specification

pH

Range	0.00 to 14.00 (1 or 2 point calibration)
Resolution	0.01
Accuracy	±0.02
Auto. buffer recognition	4.00, 7.00, 9.22, 10.00

Conductivity

Ranges	5 auto-selected from 0 to 199.9mS
Resolution	0.01µS to 0.1mS
Accuracy	±0.5% ±2 digits
Cell constant	0.01 to 19.99
Automatic std recognition	10µS, 84µS, 1413µS, 12.88mS (with manual override)

TDS

Range	5 auto-selected from 0 to 199.9g/l
Resolution	0.01mg/l to 0.1g/l
Accuracy	±0.5% ±2 digits
EC ratio (TDS)	0.50 to 0.80

Temperature

Range	-9.9 to 99.9°C
Resolution	0.1°C
Accuracy	±0.5°C
ATC and manual	0 to 99.9°C
Temperature coefficient	0.00 to 4.00%/°C
Reference temperature	18, 20 or 25°C
Connector	mini-DIN
Power	2 AA batteries
Size (l x w x d), mm	175 x 75 x 35
Weight, g	250

Key Features

- Simultaneous display of pH, conductivity and temperature
- Automatic or manual calibration
- Combined pH, conductivity and temperature probe
- Power on self check routine
- Auto-selecting ranges for both TDS and conductivity modes



430

Part code: 430 271

Ordering Information

Part Code	Description
430 271	430 conductivity/pH meter supplied with combined pH/conductivity probe (430 231), buffer sachets, batteries (fitted) and free carry case

Key Features

- Simultaneous display of pH and conductivity
- 2 independent channels to prevent interference between probes
- Additional modes for resistivity, salinity, TDS and mV
- Data logger with auto save/print options
- Storage of up to 500 readings (250 for each mode)



3540

Part code: 354 001



3540

Bench Combined Conductivity/pH Meter

The 3540 is ideal for use in all laboratories where pH and conductivity analyses are required. The setup menu gives quick and easy access to the whole range of instrument, pH and conductivity measurement options. Calibration of both channels is automatic, with the option to select 1, 2 or 3 calibration points. The pH channel can also display mV values if required.

Technical Specification

pH

Range	-2.000 to 20.000
Resolution	0.001/0.01/0.1
Accuracy	±0.003

mV

Range	±1999.9mV
Resolution	0.1mV
Accuracy	±0.2mV

Conductivity

Range	Auto-selected from 0.01µS to 1.999S
Resolution	0.01µS to 1mS
Accuracy	±0.5% ±2 digits

Temperature

Range	-10 to 105°C
Resolution	0.1°C
Accuracy	+0.5°C
ATC and manual	0 to 100°C
Temperature coefficient	0.00 to 4.00%/°C
Reference temperature	18, 20, 25°C
GLP	Calibration reminder interval, operator and sample ID and security coded setup
Outputs	Analogue, RS232 and IrDA interface
Connectors	BNC (pH) and 7-pin DIN (conductivity)
Power	9V AC ±10% @ 50/60Hz*
Size (l x w x d), mm	210 x 250 x 55
Weight, g	850
	* Voltage variants available see page 94

Ordering Information

Part Code	Description
354 001	3540 conductivity/pH meter supplied with glass combination pH electrode (924 005), glass conductivity probe (K=1, 027 013), electrode stand and holder, (903 300) ATC probe (027 500), BNC shorting plug, pH buffers and UK power supply (021 030)

Conductivity Cells

Conductivity Accessories and Consumables

Ordering Information

Part Code	Description	Unit
027 298	Epoxy bodied conductivity cell, K=1	470
027 801	Epoxy bodied conductivity cell, K=0.1	470
027 802	Epoxy bodied conductivity cell, K=10	470
924 067	Replacement pH electrode	430
430 231	Replacement combined pH/conductivity probe	430
027 013	Glass bodied conductivity cell, K=1	Bench
027 113	Glass bodied conductivity cell, K=0.1	Bench
027 211	Glass free/epoxy conductivity cell, K=0.1	Bench
027 212	Glass free/epoxy conductivity cell, K=1	Bench
027 213	Glass free/epoxy conductivity cell, K=10	Bench
027 900	Ultra-pure water conductivity probe	Bench
027 502	PTFE-coated ATC probe for use with aggressive/corrosive samples	3540



Part code: 027 298



Part code: 027 801



Part code: 027 802



Part code: 027 113



Part code: 027 212



Part code: 027 900

Standards and Buffers

Conductivity Accessories and Consumables

Ordering Information

Part Code	Description
025 156	12.88mS conductivity standard (500ml)
025 138	1413 μ S conductivity standard (500ml)
025 164	84 μ S conductivity standard (500ml)
025 139	10 μ S conductivity standard (500ml)
025 165	1382ppm TDS calibration standard (500ml)
025 157	200mV redox standard (500ml)
025 158	300mV standard (500ml)
025 159	465mV standard (500ml)

Thermal printer

Part code: 037 701



Printers and PC Software

Bench Meters 4510, 4520 and 3540

Ordering Information

Part Code	Description
037 701	Thermal printer with IrDA, complete with roll of paper (037 702), universal power adapter and interface cable for non-IrDA instruments
050 501	DataWay PC Software: includes CD-ROM and interface cable
037 551	RS232 to USB converter for use with computers without serial ports
037 801	9 way serial cable for connection to PC

Carry case

Part code: 033 269



Miscellaneous

Ordering Information

Part Code	Description
033 269	Carry case (470)
033 268	Carry case (430)
060 406	Dust cover (bench meters)
021 007	Battery (470 and 430) 2x required for each meter
903 300	Electrode stand and holder (bench meters)

Accurate, user friendly UV-visible spectroscopy

Jenway's 73 series range of spectrophotometers use icon driven software and have an improved navigation system for easy and intuitive usability. The basic models, 7300 and 7305 have measurement modes for photometrics and concentration; the advanced models, 7310 and 7315 have additional measurement modes for spectrum scanning, quantitation and kinetics.

These spectrophotometers are ideal to meet the demands of a wide range of applications especially those in clinical, veterinary, environmental and general QC laboratories.

This range also includes the new Genova Plus life science spectrophotometer which is dedicated to life science analysis. This spectrophotometer allows the measurement of DNA concentrations and purity ratios using wavelengths recorded at 260, 280 and 230nm, with an optional correction at 320nm. The Genova Plus is pre-programmed with Bradford, Lowry, Biuret, BCA and Direct UV methods for protein analysis.

JENWAY

www.jenway.com



Find out more!!!

Please scan the QR/Mobile Tag with your smartphone for more information

A Bibby Scientific Brand

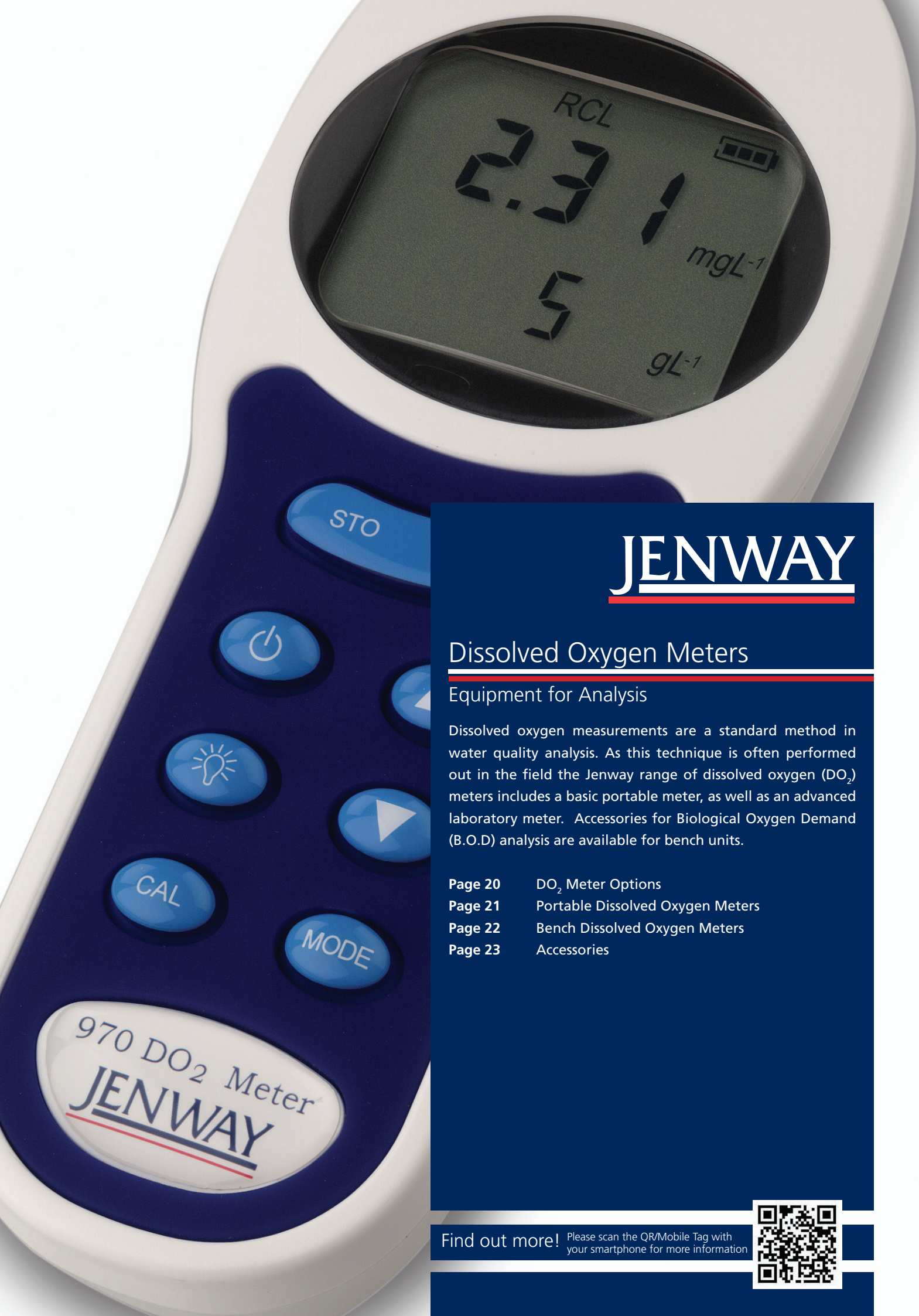

JENWAY

Dissolved Oxygen Meters

Equipment for Analysis

Dissolved oxygen measurements are a standard method in water quality analysis. As this technique is often performed out in the field the Jenway range of dissolved oxygen (DO₂) meters includes a basic portable meter, as well as an advanced laboratory meter. Accessories for Biological Oxygen Demand (B.O.D) analysis are available for bench units.

Page 20	DO ₂ Meter Options
Page 21	Portable Dissolved Oxygen Meters
Page 22	Bench Dissolved Oxygen Meters
Page 23	Accessories

Find out more! Please scan the QR/Mobile Tag with your smartphone for more information



Dissolved Oxygen Meter Options

Select the best DO₂ Meter for you

Jenway offer a choice between a basic portable Enterprise meter, model 970, which is ideal for use in the field; or a bench laboratory meter which has B.O.D capabilities, model 9500.

	970	9500
Type	Portable	Bench
DO ₂ ranges		
% air saturation	-5 to 199	0 to 199
% oxygen saturation	-5 to 25	0 to 25
Concentration (mg/l)	-5 to 19.99	0 to 19.99
Temperature	✓	✓
Temperature units	°C/°F	°C/°F
Atmospheric pressure correction	✓	✓
Salinity	-	-
B.O.D capability	-	✓
Number of results stored	32	250
GLP support	-	-
Outputs	-	Analogue RS232 IrDA

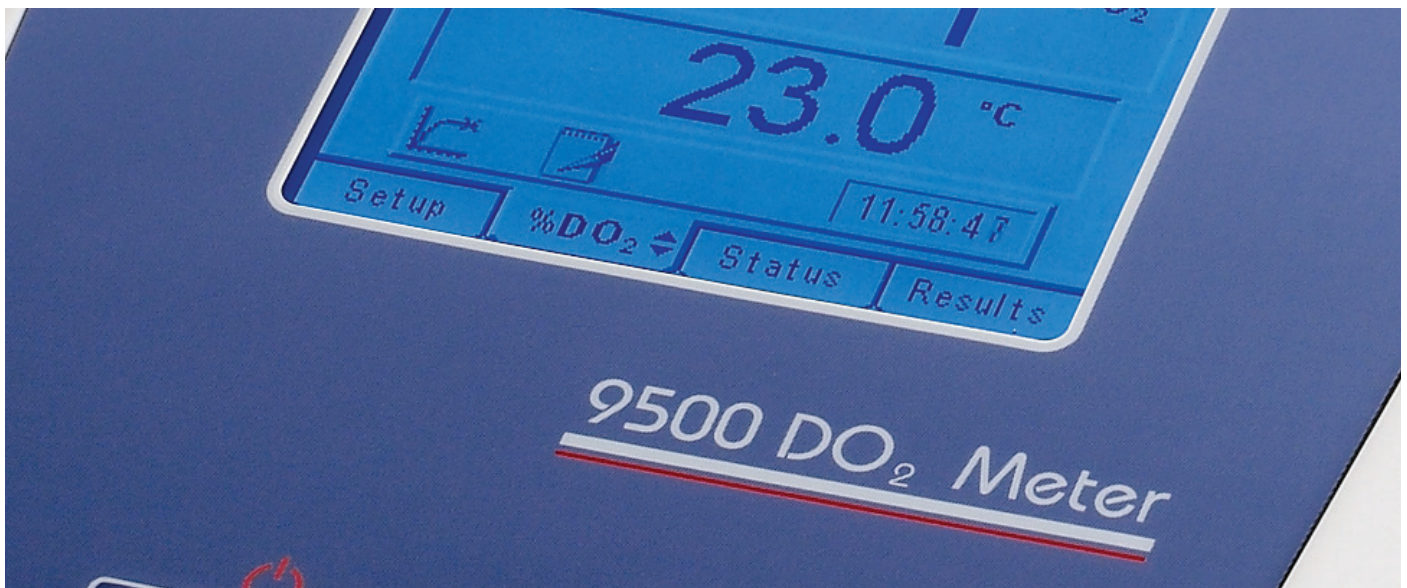

Key Features

- Portable and ideal for field work
- Results as % air saturation, % oxygen or mg/l
- Automatic calibration
- Manual atmospheric pressure and salinity correction
- Storage of up to 32 results



970

Part code: 970 271

970

Enterprise Dissolved Oxygen Meter

The 970 is a general purpose, hand held dissolved oxygen meter that combines accurate measurement and ease of use in a robust, ergonomic case. The display simultaneously shows % dissolved oxygen or oxygen concentration (mg/l) and temperature. All readings are automatically corrected for temperature with the option to manually enter corrections for pressure and salinity. The 970 is supplied with a single probe with integrated temperature measurement, allowing automatic temperature compensation as standard.

Technical Specification

DO₂

Ranges	-5 to 199%
	-5 to 25.0%
	-5 to 19.99mg/l
Resolution	1%, 0.1% or 0.01mg/l
Accuracy	±2% within 10°C of calibration temperature

Temperature

Range	-10 to +60°C
Resolution	0.1°C
Accuracy	±0.5°C
ATC range	0 to +60°C
Power	2 AA batteries
Size (l x w x d), mm	175 x 75 x 35
Weight, g	250

Ordering Information

Part Code	Description
970 271	970 dissolved oxygen meter supplied with DO ₂ probe (970 231B), spare membranes, KCl fill solution, zero calibration salts, batteries (fitted) and free carry case

9500

Bench Dissolved Oxygen Meter

The 9500 is a research meter designed for use in a number of applications including fish farming/breeding, all forms of aquaculture, environmental analysis, pollution control and effluent management. The 9500 includes powerful data logging capabilities with the ability to store 250 DO₂ readings either manually, at timed intervals or on alarmed events. The 9500 also includes full support for the B.O.D₅ day test protocol and has the ability to store up to 20 B.O.D data sets, each with up to 10 samples.

Technical Specification

DO₂

Range	0 to 199% 0 to 25.0% 0 to 19.99mg/l
Resolution	1%, 0.1%, 0.01mg/l
Accuracy	±2% within 10°C of calibration temperature

Temperature

Range	-10 to 60°C
Resolution	0.1°C
Accuracy	±0.5°C
ATC/Manual	0 to 60°C

Other

Data Logging	250 readings storage and 20 B.O.D sets (10 samples per set)
Clock	24 hour, hrs/min/sec or day/month/year, leap year corrected
GLP	Calibration reminder Alarm outputs Security code protected user data
Outputs	Analogue, RS232 and IrDA
Connector	7-pin DIN
Power	9V AC ±10% @ 50/60Hz*
Size (l x w x d), mm	210 x 250 x 55
Weight, g	850

* Voltage variants available see page 94

Ordering Information

Part Code	Description
950 001	9500 dissolved oxygen meter supplied with DO ₂ probe with ATC (522 023B), electrode holder (903 300), spare membranes, KCl fill solution, zero calibration salts, adapter bush and UK power supply (021 030)

Key Features

- Results as % air saturation, % oxygen or mg/l
- Automatic zeroing and calibration
- Atmospheric pressure and salinity correction
- B.O.D₅ measurement and calculation
- RS232 for connection to printer or PC and IrDA for cableless printing option



9500

Part code: 950 001



Ordering Information

Part Code	Description	Unit
970 231B	DO ₂ probe (mini-DIN connector)	970
541 520B	DO ₂ probe with ATC (waterproof connector)	9150/9200
522 023B	DO ₂ probe with ATC (7-pin DIN connector)	9500



Part code: 970 231B

DO₂ Probe Accessories

Ordering Information

Part Code	Description	Probes
522 019B	Replacement membranes (3) & KCl fill solution for DO ₂ probe	970 231B, 522 023B, 541 520B

B.O.D Accessories

Ordering Information

Part Code	Description	Probes
552 050	B.O.D kit contains bottle adapters, funnel and stirrer	522 023
552 050B	B.O.D kit contains bottle adapters, funnel and stirrer	522 023B, 541 520B



Part code: 522 023B with 522 050B fitted

Consumables

Dissolved Oxygen Meter Accessories

Ordering Information

Part Code	Description
541 553	KCl fill solution for DO ₂ probe (30ml)
983 030	Zero calibration powder for DO ₂ probe (5g)

Printers and PC Software

Bench Meter 9500

Ordering Information

Part Code	Description
037 701	Thermal printer with IrDA supplied with roll of paper (037 702), universal power adapter and interface cable for non-IrDA units (9500)
037 702	Roll of paper for thermal printer
050 501	Dataway PC software: includes CD-Rom and interface cable

Miscellaneous

Ordering Information

Part Code	Description
033 270	Carry case (970)
060 406	Dust cover (9500)
903 300	Electrode stand and holder (9500)
021 007	Battery (970) - 2x required



Thermal printer

Part code: 037 701



JENWAY

Flame Photometers

Equipment for Analysis

Flame photometry is the only accurate analytical method for determining certain ions concentrations and the Jenway instruments are the ideal, low cost option for measuring sodium, potassium, lithium, barium and calcium. Models for clinical or industrial samples are available.

- Page 26 Industrial Flame Photometer
- Page 27 Clinical Flame Photometer
- Page 28 Accessories and Consumables

Find out more! Please scan the QR/Mobile Tag with your smartphone for more information



PFP7

Industrial Flame Photometer

The PFP7 is a low temperature, single channel flame photometer that is designed for the routine determination of sodium, potassium, calcium, barium and lithium concentrations. The flame failure safety system makes these products ideal for use in industrial and educational environments. The use of fine and coarse sensitivity controls allows for accurate measurements each and every time.

Technical Specification

Range	0 to 199.9ppm
Limits of detection	Na 0.2ppm K 0.2ppm Li 0.25ppm Ca 15ppm Ba 30ppm
Reproducibility	<1% coefficient of variation for 20 consecutive samples using 10ppm Na set to read 50
Linearity	<2% error when 3ppm Na/K and 5ppm Li are set to read 100
Stability	<2% drift over 5 min when continuously aspirating 10ppm sample set to 50.0
Specificity	Interference from Na/K and Li equal in concentration to test element will be <0.5%
Recorder output	Nominal 1.00V for a reading of 100.0

Services

Electrical	90-125V or 190-250V @50/60Hz*
Air	Moisture and oil free, 6 litre/min @ 14psi
Fuel	Propane, butane, natural gas or LPG
Size (w x d x h), mm	420 x 360 x 300
Weight, kg	8

Ordering Information

Part Code	Description
500 701	PFP7 industrial flame photometer supplied with Na, K, Ba, Ca and Li filters, connecting hoses and clips, compressor plug and drain trap (230V/50Hz)

Note: This product will only operate with the correct type of compressor and gas regulator as specified.

* Voltage variants available see page 94

Key Features

- Designed for industrial analysis
- Supplied with Na, K, Li, Ba and Ca filters
- Low temperature, single channel
- Flame failure safety system
- Operates with propane, butane, natural gas or LPG

PFP7

Part code: 500 701



Nebuliser

Part code: 500 019

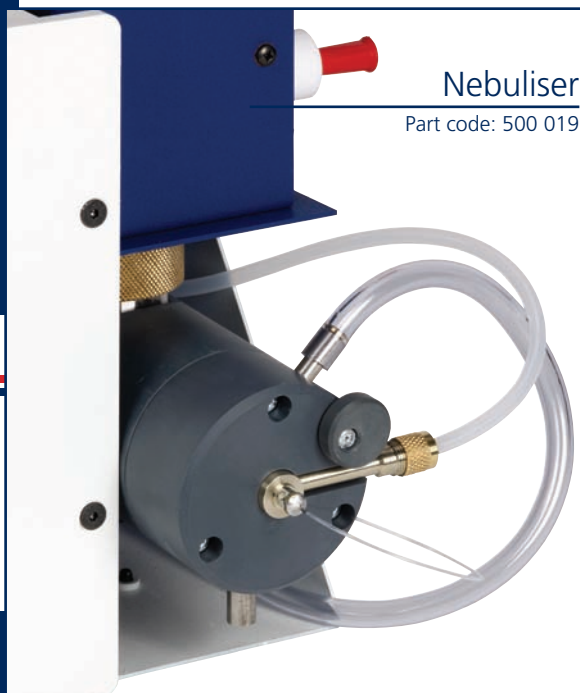

Key Features

- Designed for clinical analysis
- Supplied with Na, K and Li filters
- Low temperature, single channel
- Flame failure safety system
- Operates with propane, butane, natural gas or LPG

PFP7/C

Part code: 500 801



PFP7/C

Clinical Flame Photometer

The PFP7/C is a low temperature, single channel flame photometer that is specifically designed for use in clinical applications for the determination of sodium, potassium and lithium. The in-built lineariser circuitry of the PFP7/C enables readings of both sodium and potassium to be displayed directly in mmol/l.

Technical Specification

Range	120 to 160mmol/l Na 0 to 10.0mmol/l K
Limits of detection	Na 0.2ppm K 0.2ppm Li 0.25ppm
Reproducibility	<1% coefficient of variation for 20 consecutive samples using 10ppm Na set to read 50
Linearity	<2% error when 3ppm Na/K and 5ppm Li are set to read 100
Stability	<2% drift over 5 min when continuously aspirating 10ppm sample set to 50.0
Specificity	Interference from Na/K and Li equal in concentration to test element will be <0.5%
Recorder output	Nominal 1.00V for a reading of 100.0

Services

Electrical	90-125V or 190-250V @50/60Hz*
Air	Moisture and oil free, 6 litre/min at 14psi
Fuel	Propane, butane, natural gas or LPG
Size (w x d x h), mm	420 x 360 x 300
Weight, kg	8

Ordering Information

Part Code	Description
500 801	PFP7/C clinical flame photometer supplied with Na, K and Li filters, connecting hoses and clips, compressor plug and drain trap (230V/50Hz)

Note: This product will only operate with the correct type of compressor and gas regulator as specified.

* Voltage variants available see page 94

Accessories & Consumables

Flame Photometers

Ordering Information

Part Code	Description
535 001	Air compressor (220V/50Hz)
535 002	Air compressor (110V/60Hz)
500 176	Water separator (small)
500 177	Water separator (large)
500 093	Fuel filter
500 178	Butane regulator
500 179	Propane regulator
500 180	Natural gas regulator



Air compressor

Part code: 535 001

Clinical Standards (500ml)

Ordering Information

Part Code	Description
025 008	1.00mmol/l Li
025 004	100mmol/l Na, 100mmol/l K
025 006	140mmol/l Na, 5mmol/l K
025 007	120mmol/l Na, 2mmol/l K
025 005	160mmol/l Na, 8mmol/l K
025 027	160mmol/l Na, 80mmol/l K

Industrial Standards (500ml)

Ordering Information

Part Code	Description
025 021	1000ppm Na
025 023	1000ppm K
025 024	1000ppm Li
025 025	3000ppm Ba
025 009	1000ppm Ca
025 171	Cleaning solution (1 litre)

Butane regulator

Part code: 500 178

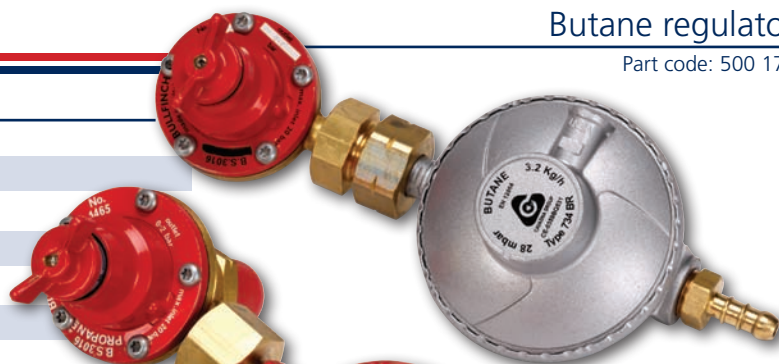

Miscellaneous

Ordering Information

Part Code	Description
500 134	Dust cover
500 172	Minor spares kit
500 019	Nebuliser

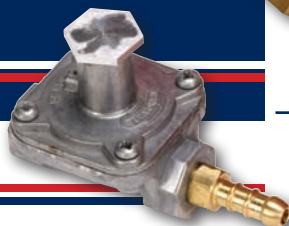

Propane regulator

Part code: 500 179





JENWAY

Fluorimeters

Equipment for Analysis

Fluorimetry has applications in water and environmental testing, food analysis and life science research, amongst others. The detection of fluorescence offers one of the most sensitive measurements in the laboratory with concentrations of less than 1ng/ml being routinely detected.

Page 30 62 Series Fluorimeters

Page 32 Filters

Page 33 Accessories

Find out more! Please scan the QR/Mobile Tag with your smartphone for more information



62 Series

Fluorimeters

Three models are available to cover a wide range of applications. The 6280 model is ideal for the most sensitive determinations with emission wavelengths up to 650nm. When higher emission wavelengths are required the 6285 with its red-enhanced detector is the unit of choice. For less sensitive applications and a broader wavelength range up to 1100nm the low cost 6270 unit is more suitable.

With press-to-read operation and Total Energy Transfer (TET) technology the output of the high-energy xenon lamp is maximised and its expected life extended so that it should never need replacing within the normal lifetime of the unit. The high quality optics are complemented by the Intelligent Filter Modules (IFM) that are identified by the unit, generating error messages should the wrong filters be fitted or their positions be incorrect.

Key Features

- High quality optics: pulsed xenon lamp and Total Energy Transfer (TET)
- Intelligent Filter Modules ensure correct filters are fitted for selected method
- Intuitive programming allows fast program creation
- Raw fluorescence or concentration values options
- Standard curve and kinetic functions
- Heated sample holder and sipper pump accessories
- Compatible with DataWay PC software



6280

Part code: 628 001

Each model offers intuitive operation with a user interface based on logical menus that can be navigated from the simple keypad. Up to 20 methods can be created without restriction and saved for future use. They can also be locked against accidental change by password entry. The permanent time and date tag on every stored reading supports Good Laboratory Practice, while calibration reminders and operator identity can also be entered to support conformance and traceability of results.

All models are powered from an external, universal mains adapter suitable for use from 90V to 230V.

Technical Specification

Parameter

Wavelength selection	Intelligent Filter Modules (IFM)
Light source	Pulsed Xenon lamp with press-to-read operation
Expected life of lamp	No replacement required in normal operation
Raw fluorescence readings	Yes
Concentration standard curve	Blank and up to 6 standards
Kinetics, timed option	In both raw fluorescence and concentration modes
Kinetics options	1 reading every 3 to 999 seconds
No. methods stored	20
No. results stored	100 per method
GLP support	Method lock with password access Time and date stamped results Last calibration date and time stored Calibration interval set and Calibration due reminder User ID
Outputs	RS232
PC software	Compatible with DataWay (option)
Sample handling	10mm square cuvette holder (standard) Heated sample holder (option) Sipper pump (option)
Power supply	90 to 230V universal mains adapter
Size (w x d x h), mm	365 x 272 x 160
Weight, kg	6

	6270	6280	6285
Wavelength range	190 to 1100nm	190 to 650nm	190 to 850nm
Sensitivity*	1µg/ml	<1ng/ml	<1ng/ml
Dynamic range*	5.2x10 ⁴	5.2x10 ⁶	5.2x10 ⁶
Detector	Photodiode	Photomultiplier tube	Photomultiplier tube

* Using quinine sulphate

Ordering Information

Part Code	Description
627 001	6270 fluorimeter supplied with 100 disposable cuvettes (060 247) and mains adapter for use on 90 to 230V supply with UK, Euro and US mains leads
628 001	6280 fluorimeter supplied with 100 disposable cuvettes (060 247) and mains adapter for use on 90 to 230V supply with UK, Euro and US mains leads
628 501	6285 fluorimeter supplied with 100 disposable cuvettes and (060 247) mains adapter for use on 90 to 230V supply with UK, Euro and US mains leads

Note: Excitation and emission filters are not included and should be purchased as separate items. Please refer to the filter section.

Fluorimeter Filters

Fluorimeter Accessories

There are 3 types of filter for the Jenway fluorimeters. The bandpass filters are ideal as excitation filters as they allow only the light between the specified wavelengths through to the sample. For example, UG1 allows all the light between 320 and 380nm through and excludes the light below 320nm and above 380nm. The cut-off and interference filters are normally used as the emission filters where a much narrower range of wavelengths is required. The cut-off filters block all light below the specified wavelength and the interference filters allow the specified wavelength and light $\pm 5\text{nm}$ of this through to the sample.

Ordering Information

Part Code	Description
627 126	UG1, 320 to 380nm bandpass filter
627 124	BG28, 380 to 500nm bandpass filter
627 125	VG9, 480 to 580nm bandpass filter
627 131	Glass, 305nm cut-off filter
627 130	Kodak 2B, 395nm cut-off filter
627 129	Kodak 8, 475nm cut-off filter
627 128	Ilford 201, 545nm cut-off filter
627 127	Kodak 29, 610nm cut-off filter



Interference Filters

Ordering Information

Part Code	Description	Part Code	Description	Part Code	Description
627 197	214nm	627 158	370nm	627 175	540nm
627 141	250nm	627 134	380nm	627 176	546nm
627 132	254nm	627 159	390nm	627 177	550nm
627 142	260nm	627 135	400nm	627 178	560nm
627 143	265nm	627 160	405nm	627 179	570nm
627 144	270nm	627 161	410nm	627 180	577nm
627 145	280nm	627 162	415nm	627 181	580nm
627 146	290nm	627 163	420nm	627 182	590nm
627 147	295nm	627 164	430nm	627 183	600nm
627 148	300nm	627 165	436nm	627 184	610nm
627 149	305nm	627 166	440nm	627 185	620nm
627 150	310nm	627 139	450nm	627 186	630nm
627 151	313nm	627 167	460nm	627 187	633nm
627 152	320nm	627 136	470nm	627 188	640nm
627 153	326nm	627 168	480nm	627 189	650nm
627 154	330nm	627 169	490nm	627 190	656nm
627 155	334nm	627 170	500nm	627 191	660nm
627 156	337nm	627 171	510nm	627 192	670nm
627 133	340nm	627 137	515nm	627 193	680nm
627 140	350nm	627 172	520nm	627 194	690nm
627 157	360nm	627 173	530nm	627 195	694nm
627 138	365nm	627 174	532nm	627 196	700nm

Key Features

- Add an air gap to separate samples
- Wash cycle
- Move sample to waste container or return to original vessel
- Pump sample continuously for monitoring a bulk or flowing sample



Sipper Pump

Part code: 632 001



Heated Cell Controller

Part code: 633 004

Sipper Pump

Fluorimeter Accessories

The programmable peristaltic sipper pump can be adjusted by the operator to inject a repeatable volume of sample or standard into the chamber of a flow-through cuvette.

Technical Specification

Continuous aspiration mode	Flow rate dependant on tubing bore: 12ml/min with supplied tubing
Timed aspiration mode	Sample/air gap/wash
Sample volume	75µl to 9.5ml
Segment run time	Up to 48 seconds
Size (w x d x h), mm	205 x 190 x 160
Weight, kg	1.5

Ordering Information

Part Code	Description
632 001	Sipper pump, supplied with inlet and outlet tubing (230V/50Hz)
632 031	Sipper pump, supplied with inlet and outlet tubing (110V/60Hz)

Heated Cell System

The electrically heated cell holder with its digital control unit ensures samples are always at the same temperature. This can be very important as fluorescence is inversely proportional to temperature, so care must be taken if comparing samples at different ambient temperatures. Temperature can also affect other sample properties, for example the rate of enzymatic reactions.

Technical Specification

Temperature range	Ambient +2°C to 60°C
Resolution	0.1°C
Regulation	±0.1°C
Accuracy	±0.5°C
Temperature control	PID
Size (w x d x h), mm	205 x 165 x 85
Weight, kg	0.9kg for controller 0.4kg for heated block

Ordering Information

Part Code	Description
628 200	Heated cell system comprising heated cell holder (628 202), controller (633 004) and connection leads (100 to 240V/50/60Hz)

PC Software

Fluorimeter Accessories

DataWay PC software allows unlimited storage of programs, results and graphs. It has powerful graphing functions that allow overlays of data for comparison of results. Alternatively data can be exported to other analysis programs such as Excel™.

Ordering Information

Part Code	Description
050 501	DataWay software on a CD-ROM, includes spectrophotometer/fluorimeter interface cable (013 210) and electrochemistry interface cable (013 203)
037 551	RS232 to USB convertor for connection to PC without serial ports

Cuvettes

Ordering Information

Part Code	Wavelength
035 120	100µl quartz cell (3 windows)
035 121	500µl glass cell (minimum 320nm, 4 windows with PTFE lid)
035 122	500µl quartz cell (minimum 200nm, 4 windows with PTFE lid)
060 253	10x10mm macro glass cell (UV, 4 windows)
060 254	10x10mm macro glass cell (visible, 4 windows)
060 255	Semi-micro flow cell (UV, 3 windows) fill volume 0.44ml
060 247	Pack of 100 (10mm) macro plastic (3ml) disposable cuvettes (visible, 4 windows)

Printers

Ordering Information

Part Code	Wavelength
037 701	Thermal printer with IrDA, complete with roll of paper (037 702), universal power adapter
037 702	Roll of thermal paper

Miscellaneous

Ordering Information

Part Code	Wavelength
021 146	Xenon lamp
033 290	Fluorimeter carry case
630 028	Dust cover



Thermal printer

Part code: 037 701

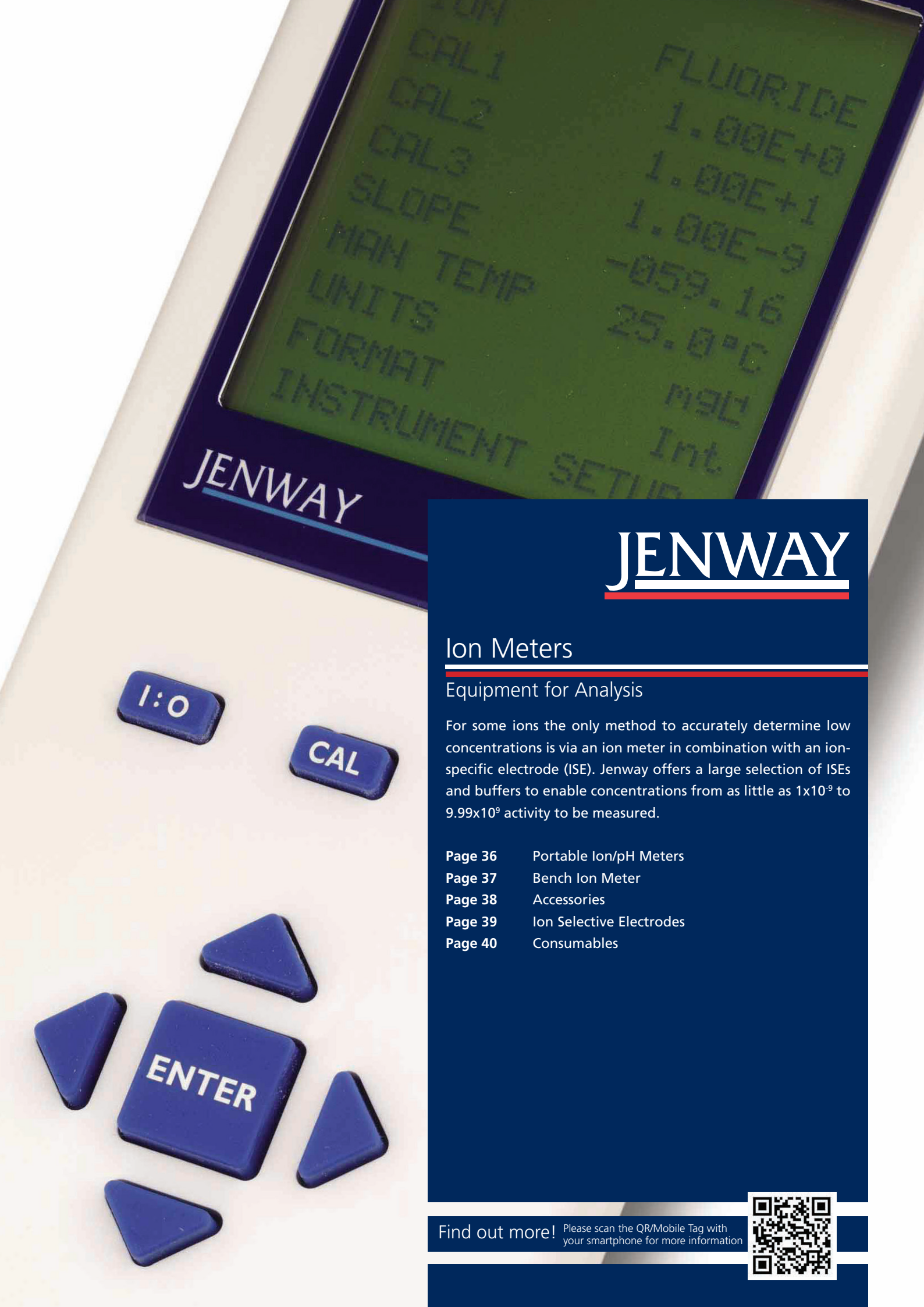

JENWAY

JENWAY

Ion Meters

Equipment for Analysis

For some ions the only method to accurately determine low concentrations is via an ion meter in combination with an ion-specific electrode (ISE). Jenway offers a large selection of ISEs and buffers to enable concentrations from as little as 1×10^{-9} to 9.99×10^9 activity to be measured.

- Page 36 Portable Ion/pH Meters
- Page 37 Bench Ion Meter
- Page 38 Accessories
- Page 39 Ion Selective Electrodes
- Page 40 Consumables

Find out more! Please scan the QR/Mobile Tag with your smartphone for more information



3205

Premier Portable Ion/pH Meter

The 3205 portable ion meter is dedicated to the rapid, easy and reliable determinations of ammonium, calcium, chloride, fluoride and nitrate ions with concentrations displayed in mg/l, ppm, %, moles, activity or no units. When performing dedicated ion analysis appropriate ATC parameters will be automatically selected and when combined with the very stable electrode readings all calibrations can be performed in the laboratory prior to analysis in the field. Although customised for dedicated ion analysis the 3205 can also perform measurements of pH, mV and other, non-dedicated ion measurements.

Technical Specification

pH

Range	-2.00 to 16.00
Resolution	0.01
Accuracy	±0.02
Auto buffer recognition	4, 7 and 10.05 (with manual override)
Calibration	User selectable 1 or 2 point

mV

Range	±1999
Resolution	1mV
Accuracy	±1mV

Temperature

Range	-10 to 105°C
Resolution	0.1°C
Accuracy	±0.5°C
ATC range	0 to 100°C
Ion	Multipoint calibration 1 to 5 points
Activity	1x10 ⁻⁹ to 9.99x10 ⁹ in integer or exponential format
Concentration units	activity, %, ppm, mg/l, moles, none
Dedicated ions	Ammonium, Calcium, Chloride, Fluoride and Nitrate
Clock	24 hour, hours/min/sec or day of month, month and year. Leap year corrected
Connector	Waterproof
Power	3x AA batteries
Size (l x w x d), mm	200 x 80 x 60
Weight, g	370

Ordering Information

Part Code	Description
539 501	3205 pH and ion meter supplied with pH/temperature probe (027 227), buffer sachets, waterproof connector to S7 electrode lead (013 161), waterproof connector to BNC electrode lead and batteries

Key Features

- Combined pH and ion portable, waterproof meter
- Ammonium, calcium, chloride, fluoride and nitrate ion measurements
- Up to 2 point pH and 5 point ion calibration
- Automatic buffer recognition
- 6 language options



3205

Part code: 539 501

Key Features

- 1 to 5 point ion calibration
- Dual channel ion/ion or ion/pH
- Automatic temperature compensation ion and pH measurements
- GLP support
- Direct potentiometry
- Full support of incremental methods



3345

Part code: 548 001

3345

Bench Ion Meter

The 3345 laboratory pH/ion meter offers a host of valuable features whilst retaining simplicity of operation through the use of structured menus. The 3345 will store up to 100 readings all of which can be recalled on the LCD screen or downloaded to a printer or PC. Details of the last calibration results are time and date stamped, thus satisfying the requirements of GLP quality assurance protocols. Offering flexibility with two additional modes of ion analysis: the known addition/subtraction mode allows the determination of ion concentrations much closer to the lower detection limits of the electrodes, whilst multiple sample addition/subtraction allows measurements to be performed in dense and concentrated matrices.

Technical Specification

pH

Calibration	1, 2 or 3 point calibration
Range	-2.000 to 19.999
Resolution	0.1, 0.01, 0.001
Accuracy	±0.003
Auto buffer recognition	4, 7 and 10.05 (with manual override)

mV

Range	±1999
Resolution	0.1mV
Accuracy	±0.2mV

Temperature

Range	-10 to 105°C
Resolution	0.1°C
Accuracy	±0.5°C
ATC Range	0 to 100°C
Ion	Multipoint calibration 1 to 5 points
Activity	1×10^{-9} to 9.99×10^9
Concentration units	Activity, %, ppm, mg/l, M or none
Clock	24 hour, leap year corrected
GLP	Calibration reminder interval (1 to 999 hrs) Timed printout interval
Outputs	Analogue and RS232
Connectors	2 x BNC (ion/pH), 5-pin DIN (temperature), 2mm pin (separate reference electrode)
Power	9V AC 230V*
Size (l x w x d), mm	275 x 240 x 150
Weight, kg	1.2

* Voltage variants available see page 94

Ordering Information

Part Code	Description
548 001	3345 dual channel ion meter supplied with glass combination pH electrode (924 005), electrode stand and holder, BNC to S7 connector (013 173) for connection to ISEs, ATC probe (027 232), buffer sachets and UK power supply

Temperature Probes and Connectors

Ion Meter Accessories

Ordering Information

Part Code	Description
013 161	Premier to S7 leadless electrode connector
027 232	ATC/temperature probe
013 173	BNC to S7 connector

Printers

Ordering Information

Part Code	Description
060 287	Paper roll
060 288	Printer ribbon
543 001	40 column serial printer with interface cable, paper, ribbon and UK power adapter

Miscellaneous

Ordering Information

Part Code	Description
544 008	Dust cover
903 300	Electrode stand and holder



Part code: 924 016



Part code: 924 017

A large number of standard ion selective electrodes (ISEs) are available for use with the Jenway ion meters. The available options include easy to use combined electrodes, separate ion-specific and reference electrodes.

Ordering Information

Ion	Combination Part Code	Mono Part Code	Reference Electrode Part Code
Ammonia	924 328	-	-
Ammonium	924 302	924 500	924 017
Barium	924 307	924 501	924 017
Bromide	924 308	924 502	924 017
Cadmium	924 309	924 503	924 017
Calcium	924 301	924 504	924 016
Carbonate	924 311	924 505	924 016
Chloride	924 304	924 506	924 017
Copper	924 313	924 507	924 017
Cyanide	924 314	924 508	924 017
Fluoride	924 305	924 509	924 016
Iodide	924 316	924 510	924 017
Lead	924 317	924 511	924 017
Mercury	924 318	924 512	924 017
Nitrate	924 300	924 513	924 017
Perchlorate	924 321	924 515	924 017
Potassium	924 322	924 516	924 017
Silver	924 323	924 517	924 017
Sodium	924 329	924 521	924 017
Sulphide	924 324	924 518	924 017
Thiocyanate	924 325	924 519	924 017
Water Hardness	924 327	924 523	924 016

Reference Electrodes for Mono ISEs

Part Code	Description
924 016	Single junction, calomel, glass bodied reference electrode
924 017	Double junction, AgCl, glass bodied reference electrode
924 036	Single junction, AgCl, glass bodied reference electrode

Note: ISEs are supplied without the connecting lead and the mono electrodes requires reference electrode to complete the system.

Ion Selective Electrode Consumables

Ion Meter Accessories

Ordering Information

Ion	ISAB	1000ppm	100ppm	10ppm	1ppm
Ammonium	025 129	025 120	025 143	025 142	-
Barium	025 099	025 069	-	-	-
Bromide	025 089	025 053	-	-	-
Cadmium	025 096	025 063	-	-	-
Calcium	025 097	025 065	025 145	025 144	-
Carbonate	025 132	025 126	-	-	-
Chloride	025 088	025 051	025 147	025 146	-
Cupric	025 093	025 057	-	-	-
Cyanide	025 091	025 134	-	-	-
Fluoride	025 107	025 087	025 150	025 149	025 148
Iodide	025 090	025 055	-	-	-
Lead	025 094	025 059	-	-	-
Magnesium	025 169	025 167	-	-	-
Mercury	025 128	025 118	-	-	-
Nitrate	025 098	025 067	025 152	025 151	-
Perchlorate	025 130	025 122	-	-	-
Potassium	025 127	025 073	-	-	-
Silver	025 095	025 061	-	-	-
Sodium	025 101	025 075	-	-	-
Sulphide	025 092	025 136	-	-	-
Thiocyanate	025 106	025 085	-	-	-
Water Hardness	025 100	025 071	-	-	-

Ion Selective Electrode Kits

Ion Meter Accessories

Part Code	Description
924 402	Ammonium electrode kit comprising ammonium ISE, 1 bottle 1000ppm calibration standard, 1 bottle ISAB and BNC to S7 lead
924 401	Calcium electrode kit comprising calcium ISE, 1 bottle of 1000ppm calibration standard, 1 bottle ISAB and BNC to S7 lead
924 404	Chloride electrode kit comprising chloride ISE, 1 bottle of 1000ppm calibration standard, 1 bottle ISAB and BNC to S7 lead
924 405	Fluoride electrode kit comprising fluoride ISE, 1 bottle of 1000ppm calibration standard, 1 bottle ISAB and BNC to S7 lead
924 400	Nitrate electrode kit comprising nitrate ISE, 1 bottle of 1000ppm calibration standard, 1 bottle ISAB and BNC to S7 lead

Note: Some ISE consumables may be subject to a minimum order quantity.



JENWAY

pH Meters

Equipment for Analysis

The Jenway pH meters range from basic portable units, right through to advanced combined pH and conductivity laboratory meters. All models, except the 3505 which is specifically designed for use in education have automatic standard recognition to ensure the accuracy of the results. Redox and ion concentration modes are available on some of the models.

Page 42	pH Meter Options
Page 43	Portable pH/mV Meters
Page 45	Portable Ion/pH Meter
Page 46	Bench pH Meters
Page 49	Combined Conductivity/pH Meters
Page 51	pH Electrodes
Page 54	Accessories and Consumables

Find out more! Please scan the QR/Mobile Tag with your smartphone for more information



pH Meter Options

Select the best pH Meter for you

	350	370	3205	3505	3510	3520
Type	Portable	Portable	Portable	Bench	Bench	Bench
Waterproof	-	-	✓	-	-	-
pH range	-2 to 16	-2 to 16	-2 to 16	-2 to 16	-2 to 20	-2 to 20
mV	-	✓	✓	✓	✓	✓
Redox	-	✓	✓	✓	✓	✓
Ion	-	✓	✓	-	-	-
ATC	-	✓	✓	-	✓	✓
No. calibration	1 or 2	1 or 2	1 or 2	-	1, 2 or 3	1, 2 or 3
Automatic buffer recognition	✓	✓	✓	-	✓	✓
Results stored	32	32	100	-	32	500
GLP support	-	-	✓	-	-	✓



Combined pH and Conductivity Meters

Select the best combined pH and Conductivity Meter for you

	430	3540
Type	Portable	Bench
Conductivity range	0 to 199.9mS	0.01µS to 1.999S
Temperature	✓	✓
Temperature units	°C/°F	°C/°F
TDS	✓	✓
Salinity	-	✓
Resistivity	-	✓
mV	-	✓
pH range	0.00 to 14.00	-2.000 to 20.000
Results storage	-	250 in each mode
GLP support	-	✓
Pure water mode	-	✓
Outputs	-	Analogue RS232

Key Features

- Simultaneous pH and temperature display
- Storage of up to 32 results
- Automatic or manual calibration 500 hours battery life
- Application specific electrodes and consumables



350

Part code: 350 271

350

Enterprise pH Meter

The 350 is a general purpose portable pH meter offering 1 or 2 point pH calibration and automatic buffer recognition with manual override. It simultaneously displays both the temperature compensated pH readings and the manually set temperature.

Technical Specification

pH	
Range	-2.00 to 16.00
Resolution	0.01
Accuracy	±0.02
Manual temperature range	0 to 100°C
Automatic buffer recognition	4.00, 7.00, 9.22, 10.00 (with manual override)
Calibration	User selectable 1 or 2 point
Connector	BNC
Power	2 AA batteries
Battery life	500 hours typical
Size (l x w x d), mm	175 x 75 x 35
Weight, g	250

Ordering Information

Part Code	Description
350 271	350 pH meter supplied with epoxy bodied combination electrode (924 001), pH buffer sachets, batteries (fitted) and free carry case

370

Enterprise Portable pH/mV Meter

The 370 hand held pH/mV meter offers simple, yet professional performance with 1 or 2 point calibration and automatic buffer recognition with manual override. The unit simultaneously displays temperature compensated pH readings or electrode potential and temperature.

A comprehensive range of application specific electrodes and consumables are available for use with the 370 meter.

Technical Specification

pH

Range	-2.00 to 16.00
Resolution	0.01
Accuracy	±0.02
Automatic buffer recognition	4.00, 7.00, 9.22, 10.00 (with manual override)
Calibration	User selectable 1 or 2 point

mV (absolute or relative)

Range	±1999mV
Resolution	1mV
Accuracy	±1mV

Temperature

Range	-10 to +105°C
Resolution	0.1°C
Accuracy	±0.5°C
ATC/Manual range	0 to 100°C
Connector	BNC
Power	2 AA batteries
Battery life	500 hours typical
Size (l x w x d), mm	175 x 75 x 35
Weight, g	250

Key Features

- pH, absolute and relative mV ranges
- Automatic or manual calibration
- Automatic or manual temperature compensation
- Simultaneous pH and temperature reading
- Storage of up to 32 results



370

Part code: 370 271

Ordering Information

Part Code	Description
370 271	370 pH/mV meter supplied with epoxy bodied combination electrode (924 001), ATC probe (027 500), pH buffer sachets, batteries (fitted) and free carry case

- Combined pH and ion portable, waterproof meter
- Ammonium, calcium, chloride, fluoride and nitrate ion measurements
- Up to 2 point pH and 5 point ion calibration
- Automatic buffer recognition
- 6 language options



3205

Part code: 539 501

Premier Portable Ion/pH Meter

The 3205 portable ion meter is dedicated to the rapid, easy and reliable determinations of ammonium, calcium, chloride, fluoride and nitrate ions with concentrations displayed in mg/l, ppm, %, moles, activity or no units. When performing dedicated ion analysis appropriate ATC parameters will be automatically selected and when combined with the very stable electrode readings all calibrations can be performed in the laboratory prior to analysis in the field. Although customised for dedicated ion analysis the 3205 can also perform measurements of pH, mV and other, non-dedicated ion measurements.

Technical Specification

pH

Range	-2.00 to 16.00
Resolution	0.01
Accuracy	±0.02
Auto buffer recognition	4, 7 and 10.05 (with manual override)
Calibration	User selectable 1 or 2 point

mV

Range	±1999
Resolution	1mV
Accuracy	±1mV

Temperature

Range	-10 to 105°C
Resolution	0.1°C
Accuracy	±0.5°C
ATC range	0 to 100°C
Ion	Multipoint calibration 1 to 5 points
Activity	1x10 ⁻⁹ to 9.99x10 ⁹ in integer or exponential format
Concentration units	activity, %, ppm, mg/l, moles, none
Dedicated ions	Ammonium, Calcium, Chloride, Fluoride and Nitrate
Clock	24 hour, hours/min/sec or day of month, month and year. Leap year corrected
Connector	Waterproof
Power	3x AA batteries
Size (l x w x d) mm	200 x 80 x 60
Weight, g	370

Ordering Information

Part Code	Description
539 501	3205 pH and ion meter supplied with pH/temperature probe (027 227), buffer sachets, waterproof connector to S7 electrode lead (013 161), waterproof connector to BNC electrode lead and batteries

3505

Bench pH Meter

The 3505 is a simple to use laboratory pH, mV and temperature meter for use in general purpose and educational applications. It utilises rotary controls for mode selection and pH calibration. A novel design feature ensures that inadvertent movement of the calibration controls has no effect during sample measurement. The large display ensures that during demonstrations and when used by groups, all can easily see the clear LCD readout.

Technical Specification

pH

Range	-2.00 to +16.00
Resolution	0.01
Accuracy	±0.02

mV

Range	±1999mV
Resolution	1mV
Accuracy	±1mV

Temperature

Range	-10 to +105°C
Resolution	0.1°C
Accuracy	±0.5°C
ATC range	0 to 100°C
Connector	BNC
Power	9V PP3 battery as standard or optional 9V power supply
Size (l x w x d), mm	210 x 250 x 55
Weight, g	850

Key Features

- Intuitive operation via rotary controls
- pH, temperature and mV mode for redox and electrode diagnosis
- Calibration controls locked during measurement
- Manual or automatic temperature compensation
- Large display
- Battery or mains operated



3505

Part code: 350 501

Ordering Information

Part Code	Description
350 501	3505 pH meter supplied with epoxy combination pH electrode (924 001), electrode stand and holder (903 300), ATC probe (027 500), BNC shorting plug, buffer sachets and battery
021 030	Optional mains power supply



Key Features

- Simultaneous readout of pH and temperature
- pH resolution to 3 decimal places
- 1, 2 or 3 point calibration
- Automatic or manual buffer selection
- Storage of up to 32 results
- RS232 connection to printer or PC via DataWay



3510

Part code: 351 001



3510

Bench pH/mV Meter

The 3510 is a versatile, simple to use pH, mV and temperature meter that is ideal for routine analysis. With up to three decimal place resolution and a choice of up to three calibration points the 3510 provides the user with added flexibility where future demands for enhanced performance may be required. A choice of pH calibration buffers to DIN, JIS and NIST standards can be used for automatic calibration, as well as manually entered buffer values.

Technical Specification

pH

Range	-2.000 to +19.999
Resolution	0.001/0.01/0.1
Accuracy	±0.003
Calibration	User selectable 1, 2 or 3 point
Automatic buffer recognition	Jenway (2.00, 4.00, 7.00, 9.20 and 10.00), DIN, NIST, JIS

mV

Range	±1999.9mV
Resolution	0.1/1mV
Accuracy	±0.2mV

Temperature

Range	-10 to 105°C
Resolution	0.1°C
Accuracy	±0.5°C
ATC and manual temperature compensation	0 to 100°C
Outputs	Analogue and RS232
Connector	BNC
Power	9V AC ±10% @ 50/60Hz•
Size (l x w x h), mm	210 x 250 x 55
Weight, g	850

Ordering Information

Part Code	Description
351 001	3510 pH/mV meter supplied with glass combination pH electrode (924 005), electrode stand and holder (903 300), ATC probe (027 500), BNC shorting plug, pH 4, 7 and 10 buffers and UK power supply (021 030)

* Voltage variants available see page 94

3520

Bench pH Meter

The 3520 dynamic pH/mV meter offers research grade specifications with a comprehensive range of features and functions, making it suitable for the broadest range of research, general laboratory, QC and GLP based applications. The built in data logger can store, print or output readings based on a wide range of trigger options, making this model suitable for monitoring and controlling pH levels.

Technical Specification

pH

Range	-2.000 to +20.000
Resolution	0.001/0.01/0.1
Accuracy	±0.003
Calibration	User selectable 1, 2 or 3 point
Auto buffer recognition	Jenway (2.00, 4.00, 7.00, 9.20 and 10.00), DIN, NIST, JIS

mV

Range	±1999.9mV
Resolution	0.1/1mV
Accuracy	±0.2mV

Temperature

Range	-10 to 105°C
Resolution	0.1°C
Accuracy	±0.5°C
ATC and manual temperature correction	0 to 100°C
Alarm points	-2.000 to 19.999pH
GLP	Calibration reminder interval (1 to 999hrs) Alarm outputs (open collector and audible). Security code protected data
Outputs	Analogue, RS232 and IrDA
Connector	BNC
Power	9V AC ±10% @ 50/60Hz*
Size (l x w x h), mm	210 x 250 x 55
Weight, g	850

* Voltage variants available see page 94

Key Features

- Ideal for quality control and GLP applications
- Up to 3 decimal place resolution
- 1, 2 or 3 point pH calibration
- Automatic or manual buffer selection
- Multiple language options
- Storage of up to 500 results
- RS232 connection to printer or PC or infra red (IrDA) communication
- GLP support



3520

Part code: 352 001

Ordering Information

Part Code	Description
352 001	3520 pH/mV meter supplied with glass combination pH electrode (924 005), electrode stand and holder (903 300), ATC probe (027 500), BNC shorting plug, pH 4, 7 and 10 buffer sachets and UK power supply



Key Features

- Simultaneous display of pH, conductivity and temperature
- Automatic or manual calibration
- Combined pH, conductivity and temperature probe
- Power on self check routine
- Auto-selecting ranges for both TDS and conductivity modes



430

Part code: 430 271

430

Enterprise Conductivity/pH Meter

The easy to use 430 is designed to readily withstand the rigours of field work, while reliably measuring pH and conductivity. The unit allows the simultaneous readout of pH, conductivity or TDS and temperature with switched ranges for both conductivity and TDS measurements.

Technical Specification

pH

Range	0.00 to 14.00 (1 or 2 point calibration)
Resolution	0.01
Accuracy	±0.02
Auto. buffer recognition	4.00, 7.00, 9.22, 10.00

Conductivity

Ranges	5 auto-selected from 0 to 199.9mS
Resolution	0.01µS to 0.1mS
Accuracy	±0.5% ±2 digits
Cell constant	0.01 to 19.99
Automatic std recognition	10µS, 84µS, 1413µS, 12.88mS (with manual override)

TDS

Range	5 auto-selected from 0 to 199.9g/l
Resolution	0.01mg/l to 0.1g/l
Accuracy	±0.5% ±2 digits
EC ratio (TDS)	0.50 to 0.80

Temperature

Range	-9.9 to 99.9°C
Resolution	0.1°C
Accuracy	±0.5°C
ATC and manual	0 to 99.9°C
Temperature coefficient	0.00 to 4.00%/°C
Reference temperature	18, 20 or 25°C
Connector	mini-DIN
Power	2x AA batteries
Size (l x w x d), mm	175 x 75 x 35
Weight, g	250

Ordering Information

Part Code	Description
430 271	430 conductivity/pH meter supplied with combined pH/conductivity probe (430 231), buffer sachets, batteries (fitted) and free carry case

3540

Bench Combined Conductivity/pH Meter

The 3540 is ideal for use in all laboratories where pH and conductivity analyses are required. The setup menu gives quick and easy access to the whole range of instrument, pH and conductivity measurement options. Calibration of both channels is automatic, with the option to select 1, 2 or 3 calibration points. The pH channel can also display mV values if required.

Technical Specification

pH

Range	-2.000 to 20.000
Resolution	0.001/0.01/0.1
Accuracy	±0.003

mV

Range	±1999.9mV
Resolution	0.1mV
Accuracy	±0.2mV

Conductivity

Range	Auto-selected from 0.01µS to 1.999S
Resolution	0.01µS to 1mS
Accuracy	±0.5% ±2 digits

Temperature

Range	-10 to 105°C
Resolution	0.1°C
Accuracy	±0.5°C
ATC and manual	0 to 100°C
Temperature coefficient	0.00 to 4.00%/°C
Reference temperature	18, 20 or 25°C
GLP	Calibration reminder interval, operator and sample ID and security coded setup
Outputs	Analogue, RS232 and IrDA interface
Connectors	BNC (pH) and 7-pin DIN (conductivity)
Power	9V AC ±10% @ 50/60Hz*
Size (l x w x d), mm	210 x 250 x 55
Weight, g	850

* Voltage variants available see page 94

Key Features

- Simultaneous display of pH and conductivity
- 2 independent channels to prevent interference between probes
- Additional modes for resistivity, salinity, TDS and mV
- Data logger with auto save/print options
- Storage of up to 500 readings (250 for each mode)



3540

Part code: 354 001

Ordering Information

Part Code	Description
354 001	3540 conductivity/pH meter supplied with glass combination pH electrode (924 005), glass conductivity probe (K=1, 027 013), electrode stand and holder (903 300), ATC probe (027 500), BNC shorting plug, pH buffers and UK power supply (021 030)



Key Features

- Quickly reach equilibrium
- Significantly reduced response times
- Far greater reproducibility
- Significantly reduced long-term drift

pH electrode

Part code: 924 904

pH electrode

Part code: 924 905



pH Performance Electrodes

pH Meter Accessories

The advanced Jenway Performance pH electrodes are the electrodes of choice for advanced applications where faster response times and greater reproducibility are required.

	924 904	924 905
Beer	✓	✓
Blood products	✓	✓
Cement	*	✓
Cosmetics	✓	✓
Dairy products	✓	✓
Education	*	✓
Fats/cream		*
Field use		*
Fish products	*	*
High accuracy laboratories	✓	✓
Low ionic		✓
Micro samples		✓
Soil	*	*
Test tubes		*
Tris Buffer	✓	✓

✓ Electrode recommended for this sample type

* Electrode would be satisfactory for use with this sample type

If the box is left blank this indicates that the electrode is not suitable for this application

Ordering Information

Part Code	Description
924 904	4.5mm semi-micro, 90mm reach, glass bodied for small volume liquid samples, Tris buffers and use in high accuracy laboratories (max. temperature 100°C)
924 905	General purpose, glass bodied for measurements in general solutions, Tris buffers and use in high accuracy laboratories (max. temperature 100°C)

Combination pH Electrodes

pH Meter Accessories

Ordering Information

Part Code	Description
924 001	General purpose, epoxy bodied for standard measurements of general solutions (max. temperature 60°C)
924 067	Replacement pH electrode with S7 connector (430, max. temperature 60°C)
924 002	12mm stem spear type, glass bodied for measurement of soil and slurry samples
924 003	Redox (platinum), glass bodied for redox measurements
924 005	General purpose, glass bodied for standard measurements of general solutions
924 007	4.5mm semi-micro, 90mm reach, glass bodied for small volume liquid samples
924 010	Spear type, 6mm stem, glass bodied for small volume soil and slurry samples
924 078	350mm reach probe, glass bodied for measurement in flasks
924 015	Glass electrode, pH only requires separate reference electrode
924 047	3 in 1 pH/temperature, epoxy bodied (bench laboratory meters only, max. temperature 100°C)
924 070	3 in 1 combination pH/temperature, epoxy bodied (370, 3505, 3510, 3520, 3540 maximum temperature 100°C)

Application Specific Electrodes

pH Meter Accessories

Part Code	Description
924 049	Life science, 6mm micro, 150mm reach, glass bodied for test tubes and small sample volumes (maximum temperature 100°C)
924 030	Tris buffer, semi-micro with 90mm reach, glass bodied for pH measurements in biological buffers, blood and protein samples (maximum temperature 50°C)
924 050	Environmental, glass bodied, suitable for low ionic strength solutions and purified water (maximum temperature 50°C)
924 068	Environmental pH electrode with S7 connector (430, max. temperature 50°C)
924 051	Food, epoxy bodied, flat membrane, ideal for measurements of food extracts and agar plates (maximum temperature 60°C)
924 069	Food pH electrode with S7 connector (430, maximum temperature 60°C)
924 077	Jam electrode, epoxy bodied, ideal for measurements of jam and preserves
924 034	Spear knife probe, epoxy based for the measurement of solid samples
924 035	Replacement electrode for spear knife probe
924 076	Difficult applications, glass bodied for measurement of oils, biofuels and non-aqueous samples
924 079	High temperature probe, glass bodied for measurements up to 110°C
924 080	Laboratory electrode, glass bodied for measurement of aggressive chemical solutions



Part code: 924 001



Part code: 924 015



Part code: 924 070



Part code: 924 030



Part code: 924 051



Part code: 924 077



Part code: 924 076



Part code: 924 080

Waterproof Versions (Premier models)

Part Code	Description
027 227	Waterproof, general purpose, epoxy-bodied with ATC (max. temperature 100°C)
924 052	Waterproof environmental with ATC (max. temperature 50°C)
924 053	Waterproof 12mm stem spear type, glass bodied with ATC
924 054	Waterproof redox (platinum), glass bodied for redox measurements with ATC
924 055	Waterproof Tris buffer, glass bodied for pH measurements in biological buffers, blood and protein samples with ATC (max. temperature 50°C)
924 056	Waterproof food pH electrode with ATC (max. temperature 60°C)
538 014	Adapter lead with waterproof connector to BNC electrode connector

Temperature and Reference Electrodes

Ordering Information

Part Code	Description
027 500	ATC/temperature probe (370, 3505, 3510, 3520 and 3540)
027 502	PTFE-coated ATC probe for use with aggressive/ corrosive samples (370, 3505, 3510, 3520 and 3540)
924 016	Single junction, calomel, glass bodied reference electrode (max. temperature 50°C) (3205)
924 017	Double junction, AgCl, glass bodied reference electrode (max. temperature 50°C) (3205)
924 036	Single junction, AgCl, glass bodied reference electrode (max. temperature 100°C) (3205)



Part code: 027 500



Part code: 924 016



Part code: 924 017



Part code: 924 036

Printers and PC Software

Ordering Information

Part Code	Description
037 701	Thermal printer with IrDA, complete with roll of paper (037 702), universal power adapter and interface cable for non-IrDA instruments
037 702	Roll of paper for thermal printer
050 501	DataWay PC Software: includes CD-ROM and interface cable
037 551	RS232 to USB converter for use with computers without serial ports
037 801	9 way serial cable for connection to PC



Thermal printer

Part code: 037 701

Ordering Information

Part Code	Description
025 037	pH 4 buffer (red, 500ml)
025 038	pH 7 buffer (yellow, 500ml)
025 039	pH 10 buffer (clear, 500ml)
025 162	pH 9.22 buffer (500ml)
025 163	pH 2 buffer (500ml)
025 179	pH 4 buffer sachets (pack of 10)
025 180	pH 7 buffer sachets (pack of 10)
025 181	pH 10 buffer sachets (pack of 10)
025 192	pH electrode storage solution (250ml)
025 196	pH electrode fill solution 3M KCl, AgCl saturated (150ml)
025 197	4M KCl/AgCl partial gel (150ml)
025 160	3M KCl pH fill solution (150ml)
025 161	pH electrode cleaning solution (500ml)
025 157	Redox standard (200mV) (500ml)
025 158	Redox standard (300mV) (500ml)
025 159	Redox standard (465mV) (500ml)



Miscellaneous

Part Code	Description
033 267	Carry case (350)
033 268	Carry case (370 and 430)
033 162	Carry case (3205)
060 406	Dust cover for bench units
021 008	Battery (3505)
021 007	Battery (350, 370 and 430) two batteries required
903 300	Electrode stand and holder

pH Electrodes

pH Meter Accessories

For more help selecting the correct electrode for your application please contact jenwayhelp@bibby-scientific.com

✓ Recommended for application

* Suitable for application

	924 001	027 227	924 067	924 002	924 005	924 003	924 007	924 010	924 015	924 030	924 034	924 047	924 070	924 049	924 050	924 052	924 051	924 076	924 077	924 078	924 079	924 080	
Agar																	✓						
Alkalines (high)																		✓				✓	✓
Beer	✓				✓	✓			✓			✓	✓	✓	✓	✓	✓	✓	✓	✓	✓	✓	✓
Blood products	*				✓	✓			✓	*		*	✓	✓	*	✓	✓	✓	*	✓	✓	✓	✓
Bread/dough				✓				✓			✓						*						
Cement	*	*		*	✓	*	*	*	*		*	*	*	*	*	*	*	✓	*	✓	✓	✓	*
Cosmetics	✓	*		*	✓	✓	*	*	*		*	*	✓	✓	✓	✓	✓	✓	✓	✓	✓	✓	*
Dairy products	*	*		*	✓	✓	✓	✓	*		✓			✓			✓	✓	*	✓	✓	✓	*
Drinking water	*			*					*			*	*	✓					*	*	*	*	*
Education	✓	*		*	✓	*	*	*	✓	*	*	✓	*	*	✓	✓	✓	✓	✓	✓	✓	✓	✓
Fats/cream				*	*			✓	*		✓			*	*	*	*	*	*	*	*	*	*
Field use	✓	✓		✓	*			*				✓			✓	✓	✓	*	✓	*	*	*	
Fish products	*	*		*	*	*	*	✓	*		✓			*	*	*	✓	*	*	*	*	*	*
High temperature																						✓	✓
Jam/preserves																				✓			*
Lab environmental							*									✓							
Lab flasks														✓								✓	
Low ionic					✓				*					*	✓			✓		✓	✓	✓	
Meat/cheese				*				✓									✓						
Micro samples						✓	*	*	*	*	*	*	*	*	*	*	*						
Paint						✓		✓						✓			✓						✓
Photographic																		✓					✓
Soil	*	✓		✓	*	*	✓	✓	*		✓			*	*			*	*	*	*	*	*
Surface																	✓						
Test tubes							*			✓				✓								*	
Tris buffer										✓					✓								*
Viscous samples				*				*			*						✓		*				



JENWAY

Spectrophotometers

Equipment for Analysis

UV-visible spectroscopy is the measurement of the absorbance of light at a specific wavelength by a sample within the UV or visible region of the spectrum. Spectroscopy is one of the most established analytical techniques used to identify the presence and concentration of many molecular entities. As spectrophotometers are used in many applications and across multiple industries Jenway have four Spectrophotometer ranges designed to suit a wide range of budgets.

Page 58	Selecting a Spectrophotometer
Page 60	Visible and UV/Visible Spectrophotometers
Page 68	Life Science Spectrophotometer
Page 70	Micro-Volume Spectrophotometer
Page 74	Visible and UV/Visible Scanning Spectrophotometers
Page 78	UV/Visible Double Beam Spectrophotometer
Page 80	Cuvettes
Page 82	TrayCell
Page 83	Environmental Test Kits

Find out more! Please scan the QR/Mobile Tag with your smartphone for more information



Welcome to the range

Jenway offer four ranges of visible and UV/visible spectrophotometers, which have been designed to suit a wide range of budgets, industries and applications.

The 63 series are basic single beam entry-level spectrophotometers including the 6300 and 6305, which have measurement modes for absorbance, transmittance and concentration, and are ideal for routine analysis. The 63 series spectrophotometers are covered by a 3 year warranty.

The 73 series spectrophotometers are single beam spectrophotometers which use icon driven software and have an improved navigation system. The 7305 and 7315 models use a press to read xenon lamp to provide accurate readings and extend lamp life. The 7310 and 7315 introduce scanning to this range and include measurements modes for photometrics, concentration, spectrum scanning, quantitation and kinetics. This range also includes the Genova Plus and Genova Nano Spectrophotometers which are dedicated to life science analysis. The whole range is covered by a 3 year warranty including the xenon lamp.

The 67 series spectrophotometers are a range of split beam visible and UV/visible spectrophotometers that possess a host of novel features. These include a colour touch screen, secure multi-user operation, a full range of plug-in accessory modules and flash synchronised scanning which allows the 67 series to achieve scan speeds of 1500nm/min, even when scanning at a resolution of 0.1nm. The 67 series spectrophotometers are covered by a 3 year warranty including the xenon lamp.

The new 6850 is a UV/visible double beam spectrophotometer with a variable spectral bandwidth. This spectrophotometer has an integrated user interface for local control and ease of navigation. The 6850 is ideal for quality control, general research, pharmaceutical, biochemical and clinical laboratory applications. This model is covered by a 1 year warranty.

For more help selecting a spectrophotometer refer to page 92 or contact jenwayhelp@bibby-scientific.com



Selecting a Spectrophotometer

Model	Visible	UV	Scanning	Single beam	Split beam	Double beam	Bandwidth
6300	✓	-	-	✓	-	-	8nm
6305	✓	✓	-	✓	-	-	8nm
7300	✓	-	-	✓	-	-	5nm
7305	✓	✓	-	✓	-	-	5nm
7310	✓	-	✓	✓	-	-	5nm
7315	✓	✓	✓	✓	-	-	5nm
Genova Plus	✓	✓	✓	✓	-	-	5nm
Genova Nano	✓	✓	✓	✓	-	-	5nm
6700	✓	-	✓	-	✓	-	4nm
6705	✓	✓	✓	-	✓	-	4nm
6715	✓	✓	✓	-	✓	-	1.5nm
6850	✓	✓	✓	-	-	✓	0.5, 1, 2, 4, 5nm

Visible Spectrophotometers

Selecting a Visible Spectrophotometer

	6300	7300	7310	6700
Wavelength				
Range	320 to 1000nm	320 to 1000nm	320 to 1000nm	320 to 1100nm
Bandwidth	8nm	5nm	5nm	4nm
Modes				
Photometrics	✓	✓	✓	✓
Concentration	✓	✓	✓	✓
Spectrum scan	-	-	✓	✓
Kinetics	-	-	✓	✓
Quantitation	-	-	✓	✓
Multi-wavelength	-	-	-	✓
Data				
Post-scan analysis	-	-	✓	✓
File output	-	-	csv	csv or bmp
Removable media	-	-	USB	SD
PC Software	✓	✓	✓	✓
Interface	Analogue RS232	Analogue RS232	Analogue RS232	Analogue Centronics USB



UV/Visible Spectrophotometers

Selecting a UV/Visible Spectrophotometer

	6305	7305	7315	6705	6715	6850
Wavelength						
Range (nm)	198 to 1000	198 to 1000	198 to 1000	190 to 1100	190 to 1100	190 to 1100
Bandwidth	8nm	5nm	5nm	4nm	1.5nm	0.5, 1, 2, 4, 5nm
Modes						
Photometrics	✓	✓	✓	✓	✓	✓
Concentration	✓	✓	✓	✓	✓	✓
Spectrum scan	-	-	✓	✓	✓	✓
Kinetics	-	-	✓	✓	✓	✓
Quantitation	-	-	✓	✓	✓	✓
Multi-wavelength	-	-	-	✓	✓	✓
Data						
Post-scan analysis	-	-	✓	✓	✓	✓
File output	-	-	csv	csv or bmp	csv or bmp	-
Removable media	-	-	USB	SD	SD	-
PC Software	✓	✓	✓	✓	✓	✓
Interface	Analogue RS232	Analogue RS232	Analogue RS232	Analogue Centronics	Analogue Centronics USB	RS232 USB

6300 and 6320D

Visible Spectrophotometers

The 6300 is a high quality, low cost unit for spectrophotometric applications in schools and colleges, as well as in QC and testing procedures for a wide variety of services and industries. The 6320D is based on the 6300 platform and includes a domed lid which accepts taller tubes up to a height of 105mm.

Technical Specification

Wavelength

Range	320 to 1000nm
Resolution	1nm
Accuracy	±2nm
Spectral bandwidth	8nm

Photometrics

Transmittance	0 to 199.9%T
Absorbance	-0.300 to 1.999A
Accuracy	±1%T
Resolution	0.1%T, 0.001A
Stray light	<0.5%T
Noise	<1%
Stability	1%/h after 15 minutes

Concentration

Range	-300 to 1999
Resolution	0.1 to 1
Units	ppm, mg/l, g/l, M, %, blank
Factor	0 to 199.9, 1000 to 9999

Other

Light source	Tungsten halogen lamp
Outputs	Analogue and RS232
Power	<50W*
Size (w x d x h), mm	365 x 272 x 160
Weight, kg	6

Key Features

- Wavelength range of 320 to 1000nm
- Absorbance, %T and concentration modes
- Multi-parameter display with wavelength and photometric readouts
- Wide range of sampling accessories
- Domed lid of 6320D accepts tubes up to 105mm tall
- 3 year warranty

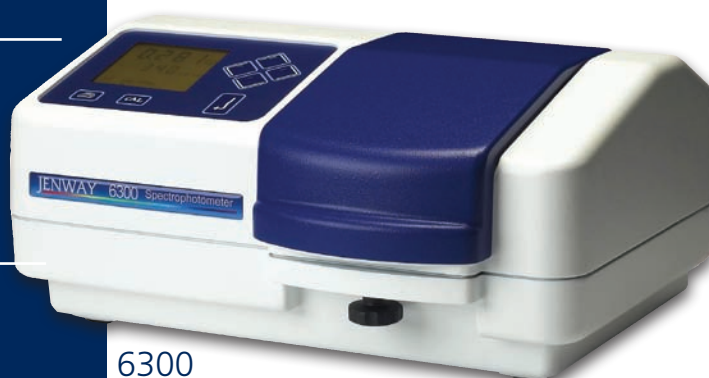

6300

Part code: 630 501



6320

Part code: 632 501

Ordering Information

Part Code	Description
630 501	6300 visible spectrophotometer supplied with mains lead, pack 100 disposable cuvettes, 10 x 10mm cell holder, interface cable and 63-Zero PC application software on CD-ROM** (230V/50Hz)
632 501	6320D visible spectrophotometer supplied with mains lead and dual cell holder (for 10mm square cuvettes and 12.7mm diameter tubes) (230V/50Hz)

* Voltage variants available see page 94

** Requires free on-line registration

Key Features

- Wavelength range of 198 to 1000nm
- Xenon lamp
- Easy and intuitive operation
- Absorbance, %T and concentration modes
- Multi-parameter display with wavelength and photometric readouts
- Wide range of sampling accessories
- 3 year warranty



6305

Part code: 635 001

6305

UV/Visible Spectrophotometer

The 6305 is ideal for applications similar to the 6300 requiring measurements in the UV and visible wavelength ranges. Using a single, pulsed xenon lamp the 6305 offers an extended lamp life and high energy throughput in the UV and visible regions.

Technical Specification

Wavelength

Range	198 to 1000nm
Resolution	1nm
Accuracy	±2nm
Spectral bandwidth	8nm, 6nm over UV range

Photometrics

Transmittance	0 to 199.9%T
Absorbance	-0.300 to 1.999A
Accuracy	±1%T
Resolution	0.1%T, 0.001A
Stray light	<0.5%T at 220 and 340nm
Noise	<0.001A at 0A at 400nm
Stability	<0.002A/h after 30 minutes

Concentration

Range	-300 to 1999
Resolution	0.1 to 1
Units	ppm, mg/l, g/l, M, %, blank
Factor	0 to 199.9, 1000 to 9999

Other

Light source	Xenon lamp
Outputs	Analogue and RS232
Power	<50W*
Size (w x d x h), mm	365 x 272 x 160
Weight, kg	6

Ordering Information

Part Code	Description
635 001	6305 UV/Visible spectrophotometer supplied with mains lead, pack 100 disposable cuvettes, 10x10mm cell holder, interface cable and 63-Zero PC application software on CD-ROM** (230/50Hz)

* Voltage variants available see page 94

** Requires free on-line registration

63 Series Accessories

63 Series Spectrophotometer

The 63 series has been specifically designed to enable a wide range of accessories to be easily fitted and used. To increase productivity Jenway offer a four position rotary cuvette holder (part code 634 001). To accommodate various sample volumes there are a wide range of passive accessories available including an adjustable cuvette holder which can hold cuvettes between 10 and 100mm; a test tube holder for test tubes with diameters between 16 and 24mm; and for small sample volumes there is a micro-cuvette holder with a reduced aperture.

Where temperature control is important Jenway offer a water heated cuvette option (part code 648 001) which requires a water bath and circulator (not supplied). For reproducible samples volumes Jenway offer an external sipper pump system (part code 632 001) which can be programmed to deliver controlled and reproducible sample volumes into the chamber of a flow through cuvette along with air and segmentation rinse cycles.

Key Features

- Water and electrically heated cuvette holders
- Adjustable path length cuvette holder
- 4 position cuvette holder
- Test tube holders
- Sipper pump



Part code: 630 204

Ordering Information

Part Code	Description
630 204	10mm path length cuvette holder
630 005	10 to 100mm path length cuvette holder
634 001	4 position manual cuvette holder
630 304	Micro-cuvette holder with reduced aperture
632 511	Dual cell holder for 10mm cuvettes and 12.7mm diameter tubes (for use with 6320D only)
637 071	10mm cuvette and 16/24mm test tube holder
636 024	Cuvette holder adapter (7.5 to 15mm beam height)
648 001	Water heated single cuvette holder

Part code: 630 005



Printers

Ordering Information

Part Code	Description
037 551	RS232 to USB converter for use with computers without a serial port
543 001	40 column printer supplied with interface cable, paper roll and ribbon and UK power adapter
060 287	Paper roll for printer
060 288	Printer ribbon
542 009	Interface cable kit

Part code: 637 071



Key Features

- Reproducible sample volumes
- Wash cycle
- Move sample to waste container or return to original vessel
- Pump sample continuously for monitoring a bulk or flowing sample



Part code: 632 001

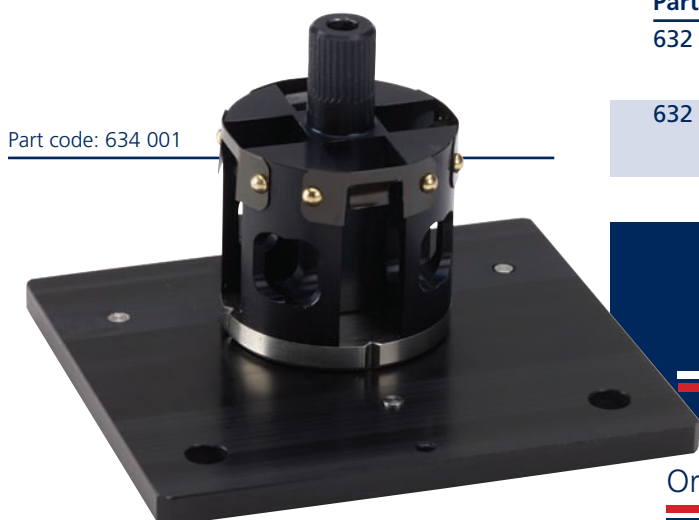

Part code: 634 001

Sipper Pump

The programmable peristaltic sipper pump can be adjusted by the operator to inject a repeatable volume of sample or standard into the chamber of a flow-through cuvette.

Technical Specification

Continuous aspiration mode	Flow rate dependant on tubing bore: 12ml/min with supplied tubing
Timed aspiration mode	Sample/air gap/wash
Sample volume	75µl to 9.5ml
Segment run time	Up to 48 seconds
Size (w x d x h)	205 x 190 x 160mm
Weight	1.5kg

Ordering Information

Part Code	Description
632 001	Sipper pump, supplied with inlet and outlet tubing (230V/50Hz)
632 031	Sipper pump, supplied with inlet and outlet tubing (110V/60Hz)

Miscellaneous

Ordering Information

Part Code	Description
630 028	Dust cover
033 290	Storage/carry case (not for use with 6320D)
012 094	Xenon lamp module (6305/6315)
012 075	Tungsten halogen lamp (6300/6320D/6310/Aquanova)

7300

Visible Spectrophotometer

The 7300 spectrophotometer uses icon driven software and has an improved navigation system for easy and intuitive usability. This instrument has measurement modes for absorbance, % transmittance and concentration. The 7300 is easy to use and is ideal for use in education and general QC laboratories.

Technical Specification

Wavelength

Range	320 to 1000nm
Resolution	1nm
Accuracy	±2nm
Spectral Bandwidth	5nm

Photometrics

Absorbance Range	-0.300 to 2.500A
Transmittance Range	0 to 199.9%T
Photometric Accuracy	±1%T, ±0.01A at 1.000 Absorbance

Concentration

Range	-300 to 9999
Resolution	Selectable 1/0.1/0.01/0.001
Units	no units, %, ppm, EBC, SRM, mEq/l, mEq, M, mM, µM, nM, U, U/l, U/ml, g/l, mg/l, µg/l, ng/l, g/dl, mg/dl, µg/dl, mg/ml, µg/ml, ng/ml, µg/µl, ng/µl, mol/l, mmol/l
Factor	0.001 to 10000
Standard	0.001 to 1000
Calibration	Blank with a single standard or factor

Other

Light Source	Tungsten halogen lamp
Outputs	Analogue, RS232, Internal printer
Size (w x d x h), mm	275 X 400 X 220
Weight, kg	6

Key Features

- Wavelength range 320 to 1000nm
- 5nm spectral bandwidth
- Icon driven software
- Small footprint
- Autologging capabilities
- 3 year warranty



7300

Part code: 730 001

Ordering Information

Part Code	Description
730 001	7300 Visible spectrophotometer fitted with a single 10x10mm cuvette holder and supplied with 100 disposable cuvettes, instruction manual, universal power supply, PC software on CD ROM and interface cable.

Key Features

- Wavelength range 198 to 1000nm
- 5nm spectral bandwidth
- Icon driven software
- Press to read xenon lamp
- Small footprint
- Autologging capabilities
- 3 year warranty including xenon lamp



7305

Part code: 730 501

7305

UV/Visible Spectrophotometer

The 7305 spectrophotometer uses icon driven software and has an improved navigation system for easy and intuitive usability. This instrument has measurement modes for absorbance, % transmittance and concentration. The 7305 is ideal for applications similar to the 7300 which require measurements in the UV range of the spectrum.

Technical Specification

Wavelength

Range	198 to 1000nm
Resolution	1nm
Accuracy	±2nm
Spectral Bandwidth	5nm

Photometrics

Absorbance Range	-0.300 to 2.500A
Transmittance Range	0 to 199.9%T
Photometric Accuracy	±1%T, ±0.01A at 1.000 Absorbance

Concentration

Range	-300 to 9999
Resolution	Selectable 1/0.1/0.01/0.001
Units	no units, %, ppm, EBC, SRM, mEq/l, mEq, M, mM, μM, nM, U, U/l, U/ml, g/l, mg/l, μg/l, ng/l, g/dl, mg/dl, μg/dl, mg/ml, μg/ml, ng/ml, μg/μl, ng/μl, mol/l, mmol/l
Factor	0.001 to 10000
Standard	0.001 to 1000
Calibration	Blank with a single standard or factor

Other

Light Source	Xenon lamp
Outputs	Analogue, RS232, Internal printer
Size (w x d x h), mm	275 X 400 X 220
Weight, kg	6

Ordering Information

Part Code	Description
730 501	7305 UV/Visible spectrophotometer fitted with a single 10x10mm cuvette holder and supplied with 100 disposable cuvettes, instruction manual, universal power supply, PC software on CD ROM and interface cable.

7310

Visible Scanning Spectrophotometer

The 7310 uses icon driven software and has an improved navigation system for easy and intuitive usability. This spectrophotometer builds on the 7300 platform with additional measurement modes for spectrum scanning, kinetics and quantitation. The 7310 is ideal for routine testing in clinical, veterinary, pharmaceutical and QC laboratories.

Technical Specification

Wavelength

Range	320 to 1000nm
Resolution	1nm
Accuracy	±2nm
Spectral Bandwidth	5nm

Photometrics

Absorbance Range	-0.300 to 2.500A
Transmittance Range	0 to 199.9%T
Photometric Accuracy	±1%T, ±0.01A at 1.000 Absorbance

Concentration/Quantitation

Range	-300 to 9999
Resolution	Selectable 1/0.1/0.01/0.001
Factor	0.001 to 10000
Standard	0.001 to 1000
Concentration Calibration	Blank with a single standard or factor
Quantitation Calibration	Blank with up to 6 standards
Quantitation Curve Fit	Quadratic, quadratic through zero, linear, linear through zero, interpolate

Kinetics

Measurement time	2 to 9999 seconds
Kinetics Calibration	Blank with a single standard or factor
Resolution	Selectable 1/0.1/0.01/0.001
Kinetics Display	Graphical and concentration value
Analysis	Concentration, rate of change, initial and final absorbance or %transmittance

Spectrum

Scan Interval	1, 2 or 5nm
Analysis	Absorbance or %transmittance and peak and valleys

Other

Method storage	240
Results storage	Limited by USB memory stick
GLP	Real time clock & calendar, operator ID
Light Source	Tungsten halogen lamp
Outputs	USB, Analogue, RS232, Internal printer
Size (w x d x h), mm	275 x 400 x 220
Weight, kg	6

Key Features

- Spectrum scanning across entire range from 320 to 1000nm
- 5nm spectral bandwidth
- Icon driven software
- Small footprint
- Autologging capabilities
- Internal method storage
- Results and method saving to USB memory stick
- 3 year warranty



7310

Part code: 731 001

Ordering Information

Part Code	Description
731 001	7310 Visible scanning spectrophotometer fitted with a single 10x10mm cuvette holder and supplied with 100 disposable cuvettes, 4GB USB memory stick, instruction manual, universal power supply, PC software on CD ROM and interface cable.

Key Features

- Spectrum scanning across entire range from 198 to 1000nm
- 5nm spectral bandwidth
- Press to read xenon lamp
- Icon driven software
- Small footprint
- Autologging capabilities
- Internal method storage
- Save results and methods to USB memory stick
- 3 year warranty including xenon lamp



7315

Part code: 731 501

7315

UV/Visible Scanning Spectrophotometer

The 7315 spectrophotometer uses icon driven software and has an improved navigation system for easy and intuitive usability. This instrument is an advanced spectrophotometer with measurement modes for photometrics, concentration, spectrum scanning, quantitation and kinetics. This model will meet the demands of a wide range of applications especially those in clinical, veterinary, environmental and general QC laboratories.

Technical Specification

Wavelength

Range	198 to 1000nm
Resolution	1nm
Accuracy	±2nm
Spectral Bandwidth	5nm

Photometrics

Absorbance Range	-0.300 to 2.500A
Transmittance Range	0 to 199.9%T
Photometric Accuracy	±1%T, ±0.01A at 1.000 Absorbance

Concentration/Quantitation

Range	-300 to 9999
Resolution	Selectable 1/0.1/0.01/0.001
Factor	0.001 to 10000
Standard	0.001 to 1000
Concentration Calibration	Blank with a single standard or factor
Quantitation Calibration	Blank with up to 6 standards
Quantitation Curve Fit	Quadratic, quadratic through zero, linear, linear through zero, interpolate

Kinetics

Measurement time	2 to 9999 seconds
Kinetics Calibration	Blank with a single standard or factor
Resolution	Selectable 1/0.1/0.01/0.001
Kinetics Display	Graphical and concentration value
Analysis	Concentration, rate of change, initial and final absorbance or %transmittance

Spectrum

Scan Interval	1, 2 or 5nm
Analysis	Absorbance or %transmittance and peak and valleys

Other

Method storage	240
Results storage	Limited by USB memory stick
GLP	Real time clock & calendar, operator ID
Light Source	Xenon lamp
Outputs	USB, Analogue, RS232, Internal printer
Size (w x d x h), mm	275 x 400 x 220
Weight, kg	6

Ordering Information

Part Code Description

731 501	7315 UV/Visible scanning spectrophotometer fitted with a single 10x10mm cuvette holder and supplied with 100 disposable cuvettes, 4GB USB memory stick, instruction manual, universal power supply, PC software on CD ROM and interface cable.
---------	--

Genova Plus

Life Sciences Spectrophotometer

The new Genova Plus is a UV/visible spectrophotometer dedicated to life science analysis. This spectrophotometer is based on the successful 73 series spectrophotometers therefore it has all of the same features including icon driven software and an improved navigation system for easy and intuitive usability.

The Genova Plus has pre-programmed methods for the measurement of nucleic acid concentrations and protein assays. This spectrophotometer also has measurement modes for the purity of nucleic acids and optical density for cell harvesting.

As well as the dedicated life science measurement modes this versatile instrument can also be used as a standard spectrophotometer with measurement modes for photometrics, concentration, multi-wavelength, spectrum scanning, quantitation and kinetics.

The Genova Plus is pre-programmed with methods for the measurement of ssDNA, dsDNA, RNA and oligonucleotide concentrations using wavelengths recorded at 260, 280 and 230nm, with an optional correction at 320nm. This measurement mode has the 260/280 and 260/230 ratios pre-programmed as well as a variable ratio option which enables up to 3 wavelengths to be entered as well as the correction wavelength. A dilution option is also available to calculate the original concentration of diluted samples.

For measuring protein concentrations the Genova Plus is pre-programmed with methods for Bradford, Lowry, Biuret, Bicinchoninic Acid (BCA) and Direct UV assays. This measurement mode allows up to 12 standards, with 3 replicates of each standard, to be measured to create the standard curve.

Bacterial cell cultures are routinely grown until the optical density at 600nm reaches approximately 0.4, which indicates the optimum cell number for harvesting. This measurement mode enables cell growth to be monitored by measuring absorbance. Measurements can be performed at 600nm, 595nm or any other user selected wavelength.

The Genova Plus also enables scanning across the full wavelength range from 198 to 1000nm enabling the purity of nucleic acids to be determined. The multi-wavelength measurement mode allows the sample to be measured at 4 different wavelengths, with ratio calculations and formulae with various factors to calculate concentration.

Key Features

- Pre-programmed methods for DNA/RNA analysis
- Purity scan across entire wavelength range
- Pre-programmed methods for protein analysis
- Standard spectrophotometer functions
- Press to read xenon lamp
- Icon driven software
- Small footprint
- Method and result saving to USB memory stick
- 3 year warranty including xenon lamp



Genova Plus

Part code: 736 501

Technical Specification

Wavelength

Range	198 to 1000nm
Resolution	1nm
Accuracy	±2nm
Repeatability	±0.5nm
Spectral Bandwidth	5nm

Photometrics

Absorbance Range	-0.300 to 2.500A
Transmittance Range	0 to 199.9%T
Photometric Accuracy	±1%T, ±0.01A at 1.000 Absorbance*

Concentration/Quantitation

Range	0 to 9999
Concentration Calibration	Blank with a single standard or factor
Quantitation Calibration	Blank with up to 12 standards
Quantitation Curve Fit	Quadratic, quadratic through zero, linear, linear through zero, interpolate

Multi-wavelength

Data Points	Up to 4 wavelengths
Calculations	Ratio, difference, sum, product

Kinetics

Measurement Time	2 to 9999 seconds
Display	Graphical & calculated concentration value
Analysis	Concentration, rate of change, initial and final absorbance or % transmittance

Spectrum/Purity Scan

Scan Data Interval	1, 2 or 5nm
Analysis	Absorbance or % transmittance and peaks and valleys

DNA

Measurement modes	dsDNA, ssDNA, RNA, Oligonucleotides, 260/280, 260/230, Variable Ratio
-------------------	---

Protein

Measurement modes	BCA, Bradford, Lowry, Biuret, Direct UV
-------------------	---

OD 600

Range	0.00 E-19 to 9.99 E+19
Calibration	Blank with a single standard or factor
Units	cells/ml
Factor	0.01 E-19 to 9.99E+19
Standard	0.01 E-19 to 9.99E+19

Other

Method Storage	312 (including pre-programmed methods)
Results Storage	Limited by USB memory stick
GLP Support	Real time clock & calendar, user ID
Light Source	Xenon lamp
Removable Media	USB (supplied)
Outputs	USB, Analogue, RS232, Integral printer
Size (w x d x h), mm	275 x 400 x 220
Weight, kg	6

* Assessment must be performed with a 10 x 10mm path length cuvette holder fitted

Ordering Information

Part Code	Description
736 501	Genova Plus UV/visible scanning spectrophotometer fitted with micro-cuvette holder, supplied with 10x10mm cuvette holder, pack 100 disposable micro-cuvettes, 4GB USB memory stick, instruction manual and universal power supply.

Genova Nano

Micro-volume Spectrophotometer

The new Genova Nano spectrophotometer has all the same features and benefits of the Genova Plus life science spectrophotometer with the addition of the micro-volume accessory making it even more versatile. This spectrophotometer is very simple and quick to use and its ability to measure sample volumes as low as 0.5µl conserves precious samples, reduces the need for dilutions and eliminates the requirement for cuvettes.

The Genova Nano measures small sample volumes with a high degree of accuracy and reproducibility in less than 6.5 seconds. Its stainless steel read head with an embedded quartz lens, utilizes the natural surface tension of the droplet to form the bond between the read head surfaces. Cleaning is quick and simple; wiping the read heads with a microfiber cloth removes all trace of the sample, allowing faster change over between samples and therefore increasing sample throughput.

In line with the Genova Plus, the Genova Nano has pre-programmed methods for the measurement of nucleic acid concentrations and protein assays as well as measurement modes to assess the purity of nucleic acids and optical density for cell harvesting. With pre-programmed methods for the measurement of ssDNA, dsDNA, RNA and oligonucleotide concentrations as well as Bradford, Lowry, Biuret, BCA and Direct UV methods for protein analysis.

As well as the dedicated life science measurement modes this versatile instrument can also be used as a standard spectrophotometer with measurement modes for photometrics, concentration, multi-wavelength, spectrum scanning, quantitation and kinetics.

The 3 in 1 ability of the Genova Nano to be used as a life science spectrophotometer, a standard spectrophotometer and a micro-volume spectrophotometer all in one package means it can meet the requirements of any busy laboratory.

Key Features

- 3 in 1 spectrophotometer
- Ideal for DNA, RNA and Protein measurements
- Eliminates the need for micro-volume cuvettes
- Only 0.5µl sample volume required
- Conserves precious samples
- Easy and quick to clean
- Fast measurement time
- Detects DNA concentrations as low as 2ng/µl
- Method and result saving to USB memory stick
- 3 year warranty including Xenon lamp



Genova Nano

Part code: 737 501

Technical Specification

Wavelength

Wavelength Range	198 to 1000nm
Wavelength Accuracy	±2nm
Spectral Bandwidth	5nm
Path Length	0.2 or 0.5mm (auto-ranging)

Photometrics

Absorbance Range	15 to 125A (10mm equivalent)
Absorbance Accuracy	±2% at 260nm
Absorbance Precision	<0.005A between 0 and 1A (at 260nm and 0.5mm)

Concentration/Quantitation

Maximum Concentration	6,000 ng/µl (dsDNA) (at 0.2mm)
Detection Limit	2ng/µl (dsDNA) (at 0.5mm)
Measurement Time	<6.5 seconds
Minimum Sample Size	0.5µl (at 0.2mm) 1.0µl (at 0.5mm)
Maximum Sample Size	5µl
DNA measurement modes	dsDNA, ssDNA, RNA, Oligonucleotides, 260/280, 260/230, Variable ratio
Protein measurement modes	BCA, Bradford, Lowry, Biuret, Direct UV

Other

Sample Pedestal Material	Quartz stainless steel
Light Source	Press to read Xenon lamp
Size (w x d x h), mm	275 x 400 x 220
Weight, kg	7.7

When the 10x10mm cuvette accessory is fitted the spectrophotometer conforms to the Genova Plus technical specification – see page 69 for details.

Ordering Information

Part Code	Description
737 501	Genova Nano micro-volume scanning spectrophotometer fitted with micro-cuvette accessory, supplied with 10x10mm cuvette holder, 4GB USB memory stick, instruction manual and universal power supply.



73 Series Accessories

73 Series Spectrophotometer

The 73 series has been designed to enhance productivity by offering an extensive range of accessories. Available active accessories include an automated 8 position cuvette holder, sipper pump, Peltier and a combined sipper Peltier. A full range of passive accessories can also be fitted including adjustable path length (10 to 100mm) cuvette holders, single water heated cuvette holders, test tube holders and micro-cuvette holders.

As the new Genova Plus and Genova Nano spectrophotometers are based on the 73 series range all of the accessories which are available for the 73 series spectrophotometers can be used with the Genova Plus and Genova Nano. The only exception is the boiling tube holder - this cannot be used with the Genova Plus or Genova Nano spectrophotometers.

Automatic 8 Position Cuvette Holder

To increase productivity and throughput rate there is an automated 8 position cuvette holder for multiple sample measurement. The automated cuvette holder accepts standard 10x10mm path length cuvettes. **Part code: 735 401**

Temperature Control

For applications where the temperature of the sample needs to be controlled Jenway offer two options. The first is an electronic Peltier accessory which enables sample temperature to be controlled between 20°C to 50°C. **Part code: 735 301**

The second option is a single water heated cuvette holder which requires a circulating water bath and has an operating temperature range of 5°C to 50°C. **Part code: 736 201**

Sipper Pump

For safe and effective sample handling Jenway offer a sipper pump which circulates samples and can be programmed to deliver reproducible sample volumes. A flow through cuvette must be used with the sipper pump. **Part code: 735 201**

Combined Sipper Peltier

The combined sipper Peltier pump combines the functionality of both the sipper pump and the Peltier enabling sample temperature to be controlled while the sample is being circulated. **Part code: 735 701**

Key Features

- Multiple sample measurement
- Reproducible sample volumes
- Temperature control
- Instant results
- Variable sample volumes



Part code: 735 401

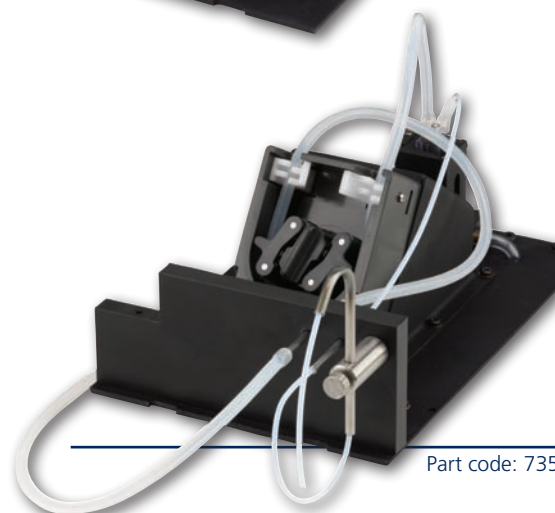

Part code: 735 201

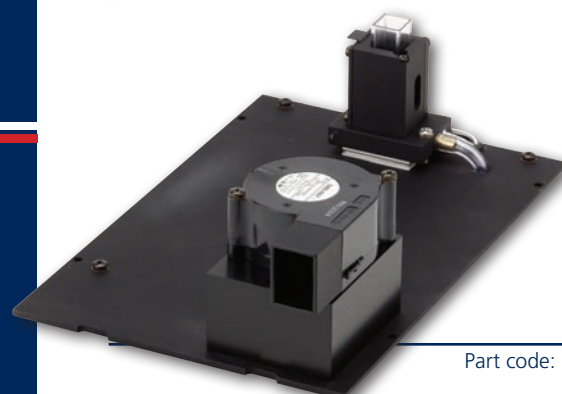

Part code: 735 301

Passive Accessories

73 Series Accessories

Part code: 735 901



Jenway also offer an extensive range of passive accessories to use with the 73 series spectrophotometers. For cuvettes with a variable path length between 10 and 100mm we offer an adjustable path length cuvette holder. **Part code: 630 005**

For small sample volumes down to 50µl we offer a micro-cuvette holder. **Part code: 630 304**

For large sample volumes we offer a test tube holder which can hold test tubes up to 100mm in height with diameters of 13, 16 and 24mm **Part code: 637 071**. Jenway also offer a boiling tube holder which can hold boiling tubes up to 150mm in height with a diameter of 25mm. **Part code: 735 601**

Part code: 736 001



Printers

For instant results Jenway offer a printer which can be easily fitted into the top of the spectrophotometer to save bench space. The integrated printer enables spectrum and kinetics curves to be printed as well as results tables and analysis summary. The user name and method parameters are printed on all results. **Part code: 660 101**

Part code: 736 201



Ordering Information

Part Code	Description
660 101	Internal printer (packed)
735 401	Automatic 8 position cuvette holder
735 201	Sipper pump
735 301	Peltier
735 701	Combined sipper/Peltier
630 204	10x10mm path length cuvette holder
630 005	10 to 100mm path length cuvette holder
637 071	16/24mm test tube holder
630 304	Micro-cuvette holder with reduced aperture
736 201	Water heated 10x10mm path length cuvette holder
735 601	Boiling tube holder
735 001	Dust cover
019 146	4GB USB Memory stick for external memory (7310/7315 only)
012 075	Tungsten halogen lamp (7300/7310)
012 146	Xenon lamp module (7305/7315)

Part code: 660 101



67 Series

Visible and UV/Visible Scanning Spectrophotometers

All three instruments have modes for photometrics, spectrum scanning, multi-wavelength analysis, kinetics and quantitation, giving direct concentration results against single or multi-point calibrations. With extensive post measurement tools to ensure results are presented exactly to each user's requirements the 67 series also offers significant advances in data portability. Together, the touch screen and colour display give the fastest, most flexible instrument interface possible. Where fine cursor control is required, using the QWheel™ makes the task easy and precise.

Jenway have developed secure multi-user operation for when instruments are shared by a number of users, so access to the instrument functions is controlled through a secure log-in procedure. For maximum security PIN codes can be allocated to individuals, groups or departments and to further increase flexibility each method can be given three levels of security:

Public	Access is free to all users.
Read only	Methods can be accessed by all users, but only modified by the originator.
Personal	Method can only be accessed by the logged in user

Key Features

- Colour touch screen display
- High quality, sealed split beam optics for optimum photometric performance
- Secure multi-user operation
- Save to SD memory card
- Enhanced productivity
- Extensive range of accessories for flexibility and improve productivity
- 3 year warranty including xenon lamp

67 Series

Part code: 670 0B0

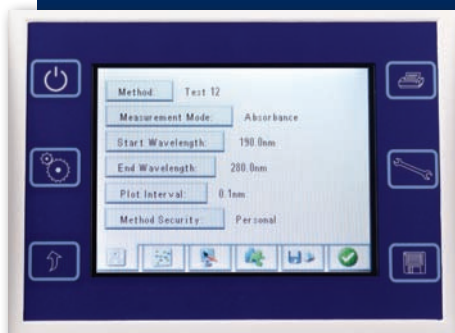

The spectrophotometer's internal memory can be copied to the removable SD card which enables easy cloning of multiple instruments, ensuring common laboratory practice and speeding set-up in busy teaching establishments.

Data can be transferred from the spectrophotometers using the removable SD card or via direct transfer, using the USB port, to a PC. Using the PC software provided the data can be viewed, exported, saved or printed.

The 67 series spectrophotometers are very versatile and flexible instruments with an extensive range of accessories which have been specifically designed to be easily interchangeable.



QWheel is a registered trademark of Quantum Research

Technical Specification

Wavelength

Range	320 to 1100nm (6700)	190 to 1100nm (6705, 6715)
Spectral bandwidth	4nm (6700, 6705)	1.5nm (6715)
Resolution	0.1nm	
Accuracy	±1.0nm	
Repeatability	±0.2nm	

Photometrics

Transmittance	0 to 199.9%T	
Absorbance	-0.300 to 3.000A	
Accuracy	±0.005A at 1.0A	
Resolution	0.1%T, 0.001A	
Stability	<0.001A/h after warm-up	
Stray light	<0.1%T at 340nm (6700)	<0.05% at 220nm (6705, 6715)

Quantitation

Range	-99999 to +99999
Calibration	Up to 20 standards with 5 replicates of each
Units	mEq/l, ppm, mg/l, g/l, %, µg/ml, mg/ml, g/dl, mg/dl, µg/l, ng/l, µg/dl, M, mM, µM, U/l, mU/l, U/ml, blank
Curve fit algorithms	Linear, quadratic and cubic functions

Multi-wavelength

Data points	Up to 4 wavelengths
Calculations	Ratio, difference, formulae with factors

Kinetics

Time limits	0 to 9999 seconds
Calibration	Standard or factor
Analysis	Curve details with mean rate of change plus formula of line of best fit

Spectrum

Range	Any range between 320 (6700) or 190 (6705, 6715) and 1100nm
Scan speed	1500nm/min
Scan interval	0.1nm
Analysis	Auto peaks and valleys, zoom, addition, subtraction, peak ratios, smoothing, area under curve, wavelength table, derivatives, analysis points, overlay

Other

Light source	Tungsten halogen lamp (6700) Xenon lamp (6705, 6715)
Configuration	Secure multi-user and free access
Number of users	10 users + supervisor
Methods/results memory	>500 on internal flash memory or removable media
Removable media	SD memory card
Outputs	USB, Centronics, Analogue, Internal printer
Size (w x d x h), mm	490 x 390 x 220
Weight, kg	7.5

NOTE: All 67 Series spectrophotometers are supplied with 2GB of internal memory, 2GB SD memory card, 100 disposable cuvettes, instruction manual, power cable and PC software on CD ROM with interface cable.



Ordering Information

Part Code	Description
670 0B0	6700 Visible Scanning Spectrophotometer fitted with a single 10 x 10mm cuvette holder
670 5B0	6705 UV/Visible Scanning Spectrophotometer fitted with a single 10 x 10mm cuvette holder
671 5B0	6715 UV/Visible Scanning Spectrophotometer fitted with a single 10 x 10mm cuvette holder

67 Series Accessories

The 67 series spectrophotometers are very versatile and flexible instruments with an extensive range of accessories available which have been specifically designed to be easily interchangeable. All three models are fitted with a single 10x10mm cuvette holder as standard therefore the required accessories must be purchased separately.

The active accessories include an 8-cell automatic turret, 6-cell water heated automatic turret, sipper pump, Peltier and combined sipper/Peltier and are supplied in a sample chamber which can be easily fitted into place without the requirement of any tools. When the active accessories are fitted the instrument automatically detects which accessory has been fitted when performing its warm up checks.

The passive accessories include an adjustable path length cuvette holder for cuvettes with a variable path length between 10 and 100mm, a micro-cuvette holder for small sample volumes and a test tube holder. There is also a single water heated cuvette holder for temperature control. Please note that a water bath and circulator are required for this accessory but not supplied.

Peltier Controlled Cuvette Holder

The Peltier controlled cuvette holder allows precise control of sample temperature in the range of 20 to 50°C to a resolution of 0.1°C. **Part code: 660 301**

Programmable Sipper Pump

A programmable sipper pump can also be fitted, enabling controlled sample volumes to be injected into micro and standard flow-through cuvettes. Air segmentation and rinse cycles can also be programmed for sensitive applications. **Part code: 660 201**

Peltier Sipper Pump

For sensitive applications a combined Peltier sipper module is also available. This accessory incorporates the the features and functions of both the Peltier and sipper pump. **Part code 660 701**

Six and Eight Position Cell Holders

The automated eight and six-position cell holder accessories are the key to improved productivity in all modes of operation. Both accept standard 10mm path-length cuvettes while the six-position accessory has the added benefit of a water jacket for sample temperature control via an external circulating water bath. **Part code 660 501**. When using the eight position cell holder the dedicated automated option enables up to 7 samples to be measured sequentially with all results saved or printed automatically. **Part code 660 401**



67 Series

Part code: 630 204 (Fitted as standard)



67 Series

Part code: 660 201, 660 401

(Sold separately)

Cell Holders

Part Code	Description
660 401	Sample chamber with automatic eight-cell changer module fitted
660 403	Additional carousel for automatic eight-cell changer (for use with 660 401)
630 204	10mm path length cuvette holder
630 005	10 to 100mm path length cuvette holder
630 304	Micro-cuvette holder with reduced aperture
637 071	10mm cuvette and 16/24mm test tube holder



Heated cell and Sipper Pump

Part Code	Description
660 501	Sample chamber with water heated automatic six-cell changer module fitted
660 503	Additional carousel for water heated automatic six-cell changer (for use with 660 501)
660 201	Sample chamber with sipper module fitted
660 301	Sample chamber with Peltier module fitted
660 701	Sample chamber with sipper/Peltier module fitted
661 201	Single cell sample chamber module fitted with water heated cuvette holder (648 001)*

* Circulating water bath required but not supplied

Printers

Part Code	Description
660 101	Internal printer (packed)
037 702	Paper roll for thermal printer
019 133	2GB SD card for external memory

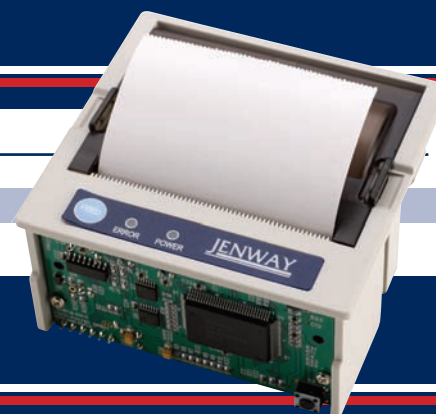

Miscellaneous

Part Code	Description
660 001	Dust cover
060 422	Moulded cuvette rack for 16 10x10mm cuvettes
035 088	Visible range calibration standards (all models)
035 091	UV/Visible calibration standards (6705/6715)
012 075	Tungsten halogen lamp (6700)
012 146	Xenon lamp module (6705/6715)

6850

UV/Visible Double Beam Spectrophotometer

The new 6850 introduces the first double beam spectrophotometer with a variable spectral bandwidth into the Jenway range. The highly stable optics and two detectors measure the sample and reference simultaneously optimising measurement accuracy. The 6850 has measurement modes for photometrics, concentration, multi-wavelength, spectrum scanning, kinetics, quantitation, DNA/RNA and protein analysis.

Jenway Prism PC software is supplied as standard and offers additional functionality with preloaded methods for DNA/RNA and protein analysis, as well as extensive post-measurement tools, unlimited results saving and easy export of data.

The 6850 is ideal for quality control, general research, pharmaceutical, biochemical and clinical laboratory applications.

Key Features

- Double beam spectrophotometer with highly stable optics
- Variable spectral bandwidth 0.5, 1, 2, 4, 5nm
- Integrated user interface
- Conforms to European Pharmacopeia requirements
- Jenway Prism PC software included as standard
- Extensive range of accessories available

Ordering Information

Part Code	Description
685-SC	6850 double beam spectrophotometer, supplied fitted with single 10x10mm cuvette holder in sample and reference position, instruction manual, power cables, PC software on CD ROM with USB connection cable and dongle, 2 x quartz cuvettes, 4 x glass cuvettes and FREE dust cover



6850

Part code: 685-SC

6850 Series Accessories

Ordering Information

Part Code	Description
685 204	10x10mm path length cuvette holder
685 131	Water heated 10x10mm single cell holder
685 005	10 to 100mm path length cuvette holder
685 304	Micro-cuvette holder
685 401	8 position automatic cell changer



Eight cell changer

Part code: 685 401

Technical Specification

Wavelength

Wavelength range	190 to 1100nm
Wavelength resolution	0.1nm
Wavelength accuracy	± 0.3nm (at 0.5 and 1nm bandwidth) ± 0.5nm (at 2, 4 and 5nm bandwidth)
Wavelength reproducibility	±0.2nm
Spectral bandwidth	Variable 0.5, 1, 2, 4, 5nm

Photometrics

Photometric range	-0.3 to 3.0A 0 to 200%T
Photometric accuracy	± 0.002A (0-0.5A) ±0.3%T (0-100%T)
Photometric reproducibility	±0.001 Abs (0 to 0.5 Abs) ±0.002 Abs (0.5 to 1.0 Abs) 0.15%T (0-100%T)
Resolution	0.1%T, 0.001A
Stray light	<0.05%T at 220 and 360nm
Noise	0.0005A
Stability	± 0.001A/h at 500nm after 15 min warm up

Multi-Wavelength

Multi-wavelength	Up to 10 wavelengths, up to 20 wavelengths with PC software
------------------	---

Spectrum

Spectrum range	Any range between 190 and 1100nm
Scan speed	100 to 2000nm/min
Scan interval	0.1, 0.2, 0.5, 1, 2 or 5nm
Analysis	Auto peaks and valleys, zoom, addition, subtraction, peak ratios, smoothing, area under curve, wavelength table, derivatives, overlay with PC software

Kinetics

Kinetics	Up to 12 hours with time intervals of 0.1, 0.2, 0.5, 1, 2, 5, 10 or 30 seconds
----------	--

Quantitation/Concentration

Quantitation points	Up to 3 wavelengths
Quantitation Calibration	Blank with up to 10 standards or factor
Concentration range	0-99999
Calibration	Blank with standards or factor

DNA

DNA/RNA and Protein	DNA/RNA Ratio, concentration, A320 correction
---------------------	---

Other

Light source	Tungsten halogen and Deuterium lamps
Lamp changeover	325 to 370nm selectable
Outputs	USB and parallel
Operating system:	Windows 2000, XP, Vista, Windows 7
Electrical supply	120VA, 220/110V, 50/60Hz
Size (w x d x h), mm	600 x 450 x 200
Weight, kg	22

Cuvettes

Spectrophotometer Accessories

Jenway offer a range of glass and quartz cuvettes as well as disposable plastic cuvettes. The glass and quartz cuvettes are available in a range of path lengths from 10 to 100mm. Jenway also offer a range of glass and quartz flow-through and micro-volume cuvettes. Glass cuvettes are suitable for measurements in the visible region whereas quartz cuvettes may be used in both the UV region and visible region.

Disposable Cuvettes

Ordering Information

Part Code	Material	Description	Visible wavelength	UV/Visible wavelengths	Fill volume
060 084	Plastic	Pack of 100 plastic cuvettes	✓	-	2.4 to 4.5ml
060 229	Plastic	Pack of 500 plastic cuvettes	✓	-	2.4 to 4.5ml
060 087	Plastic	Pack of 100 plastic cuvettes	✓	-	1.5 to 3.0ml
060 230	Plastic	Pack of 100 plastic cuvettes,	✓	✓	2.5 to 4.5ml
060 232	Plastic	Pack of 500 plastic cuvettes,	✓	✓	2.5 to 4.5ml
060 231	Plastic	Pack of 100 UV plastic cuvettes,	✓	✓	1.5 to 3.0ml
035 143	Plastic	Pack of 100 plastic cuvettes, UV	✓	✓	70µl to 1.5ml

Glass Cuvettes

Ordering Information

Part Code	Material	Description	Visible wavelength	UV/Visible wavelengths	Path length	Fill volume
035 027	Glass	10mm path length cuvette	✓	-	10mm	2.0 to 3.5ml
035 086	Glass	20mm path length cuvette	✓	-	20mm	Up to 7.0ml
035 029	Glass	40mm path length cuvette	✓	-	40mm	Up to 14.0ml
035 087	Glass	50mm path length cuvette	✓	-	50mm	Up to 17.5ml
035 079	Glass	100mm path length cuvette	✓	-	100mm	Up to 35.0ml
035 123	Glass	Micro (500µl) cuvette	✓	-	10mm	500µl
035 126	Glass	Semi-micro (1ml) cuvette	✓	-	10mm	1ml

Ordering Information

Part Code	Material	Description	Visible wavelength	UV/Visible wavelengths	Path length	Fill volume
035 045	Glass	Flow-through cell	✓	-	10mm	80µl
035 044	Quartz	Flow-through cell	✓	✓	10mm	1.8ml
035 047	Quartz	Flow-through cell	✓	✓	10mm	80µl

Quartz Cuvettes

Ordering Information

Part Code	Material	Description	Visible wavelength	UV/Visible wavelengths	Path length	Fill volume
035 028	Quartz	10mm path length cuvette	✓	✓	10mm	2.0 to 3.5ml
035 056	Quartz	20mm path length cuvette	✓	✓	20mm	Up to 7.0ml
035 030	Quartz	40mm path length cuvette	✓	✓	40mm	Up to 14.0ml
035 281	Quartz	50mm path length cuvette	✓	✓	50mm	Up to 17.5ml
035 282	Quartz	100mm path length cuvette	✓	✓	100mm	Up to 35.0ml
035 124	Quartz	UV ultra micro (50µl) cuvette	✓	✓	10mm	50µl
035 125	Quartz	UV micro (500µl) cuvette	✓	✓	10mm	500µl
035 127	Quartz	UV semi-micro (1ml) cuvette	✓	✓	10mm	1ml
035 138	Quartz	UV ultra-micro (100µl) cuvette	✓	✓	10mm	100µl

TrayCell

Spectrophotometer Accessories

- Ideal for DNA, RNA and protein measurements
- Sample volumes as low as 0.7 μ l
- Sample concentration range from 25 to 4250 μ g/ml
- Sample is simply wiped away after the measurements, making the TrayCell quick and easy to use
- Prevents dilution and pipetting errors
- Fits all standard 10 x 10mm cuvette holders

The TrayCell is a fibre optic cuvette which can be used with as little as 0.7 μ l of sample. The cuvette has two caps which give path lengths of either 1mm or 0.2mm, thus creating a 'virtual dilution' of 1:10 or 1:50 of the sample when compared to a measurement with a standard 10 mm cuvette

Technical Specification

Light Path	0.2mm or 1mm
Error of light path	± 0.02 mm
Volume	0.7-5 μ l
Wavelength range	190 to 1100nm
Maximum temperature	50 $^{\circ}$ C

Ordering Information

Part Code	Description
035 262	TrayCell for ultra-micro sample volumes from 0.7 to 5 μ l compatible with Genova Plus, 6705 and 6715 spectrophotometers, supplied complete with caps for 1mm and 0.2mm path length operation
035 263	Replacement 1mm path length cap for TrayCell
035 264	Replacement 0.2mm path length cap for TrayCell



TrayCell

Part code: 035 262

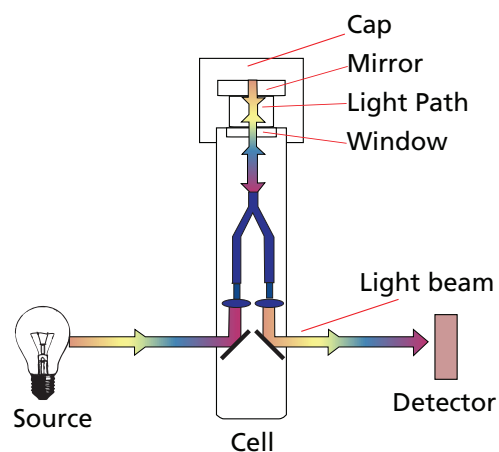

Environmental Test Kits

Spectrophotometer Accessories

Jenway environmental test kits offer the simplest and most convenient laboratory system for measuring a broad range of parameters in water, wastewater, effluent and environmental samples. Jenway environmental test kits contain 25, 50 or 100 tests (depending upon test kit).



Ordering Information

Part Code	Description	Range	No. of tests	Vials Required	Vial Part Code
025 300	Alkalinity m	5 - 200mg/l CaCO ₃	100	24mm	060 425
025 301	Alkalinity p	5 - 300mg/l CaCO ₃	100	24mm	060 425
025 302	Aluminium	0.01 - 0.25mg/l	100	24mm	060 425
025 303	Ammonia	0.02 - 1.0mg/l N	100	24mm	060 425
025 304	Ammonium LR	0 - 2.5 mg/l N	50	24mm	060 425
025 305	Ammonium HR	1 - 50 mg/l N	50	Supplied	-
025 306	Bromine	0.1 - 6.5 mg/l	100	Supplied	-
025 338	Chloride	0.5 - 25 mg/l	100	24mm	060 425
025 307	Chlorine (Free)	0.05 - 3 mg/l	100	24mm	060 425
025 308	Chlorine (Total)	0.05 - 3 mg/l	100	24mm	060 425
025 309	Chlorine Dioxide	0.5 - 2.5 mg/l	100	24mm	060 425
025 314	Chromium (Hex)	0.02 - 2 mg/l	100	24mm	060 425
025 313	Chromium (Total)	0.02 - 2 mg/l	100	24mm	060 425
025 312	COD (HR)	1000 - 15000 mg/l O ₂	25	Supplied	-
025 310	COD (LR)	0 - 150 mg/l O ₂	25	Supplied	-
025 311	COD (MR)	100 - 1500 mg/l O ₂	25	24mm	060 425
025 316	Copper (free)	0.5 - 5 mg/l	100	24mm	060 425
025 315	Copper (Total)	0.5 - 5 mg/l	100	24mm	060 425
025 317	Fluoride	0.02 - 1.5 mg/l	100	24mm	060 425
025 318	Hardness Total	2 - 50mg/l CaCO ₃	100	24mm	060 425
025 320	Hydrogen Peroxide	0.5 - 1.5mg/l	100	24mm	060 425
025 321	Iodine	0.05 - 3.6 mg/l	100	24mm	060 425
025 322	Iron (soluble)	0.1 - 3mg/l	100	24mm	060 425
025 323	Manganese	0.05 - 4mg/l	100	24mm	060 425
025 324	Molybdate	0.5 - 30mg/l	100	24mm	060 425
025 325	Nitrate	1 - 30 mg/l	50	Supplied	-
025 326	Nitrite	0.01 - 0.5mg/l	100	24mm	060 425
025 327	Nitrogen Total (LR)	0.5 - 25mg/l	50	Supplied	-
025 328	Nitrogen Total (HR)	5 - 150mg/l	50	Supplied	-
025 330	Orthophosphate	0.05 - 4mg/l	100	24mm	060 425
025 329	Oxygen Active	0.1 - 10mg/l	100	24mm	060 425
025 331	pH	6.5 - 8.4	100	24mm	060 425
025 332	Potassium	0.5 - 12 mg/l	100	24mm	060 425
025 333	Silica	0.05 - 3mg/l	100	24mm	060 425
025 334	Sulphate	2 - 100mg/l	100	24mm	060 425
025 335	Sulphide	0.05 - 0.5mg/l	100	24mm	060 425
025 336	Sulphite	0.05 - 4mg/l	100	24mm	060 425
025 337	Zinc	0.02 - 1mg/l	100	24mm	060 425

Ordering Information

060 425	24mm screw cap vial (Pack of 24)
060 426	16mm screw cap vial (Pack of 20)

73 Series PC Software

Downloadable from www.Jenway.com

Models 7300, 7305, 7310 and 7315 are supplied with free bi-directional PC software which enables the instrument to be controlled via the PC. The PC software suite features measurement modes for photometrics, concentration, spectrum scanning, quantitation and kinetics as well as enhanced data manipulation tools. Results can easily be exported to Excel® and charts can simply be copied. The PC software suite increases the number of results and methods which can be stored and it enables multiple results to be displayed simultaneously as well as spectrum and kinetics curves.

Through RS232 connection to PC, the software provides full emulation of all the instrument's functions and enables the instrument to be directly driven from a PC. The PC software also enables any optional accessories to be driven from a PC.

The settings menu in each measurement mode enables easy and simple set up of method parameters which can be saved for future use. The print options menu enables printouts to be customised to your requirements. Options available include results tables, spectrum and kinetics curves and analysis results. The user login identification and summary of the method parameters are also printed to enable traceability of results.



7315

Part code: 731 501

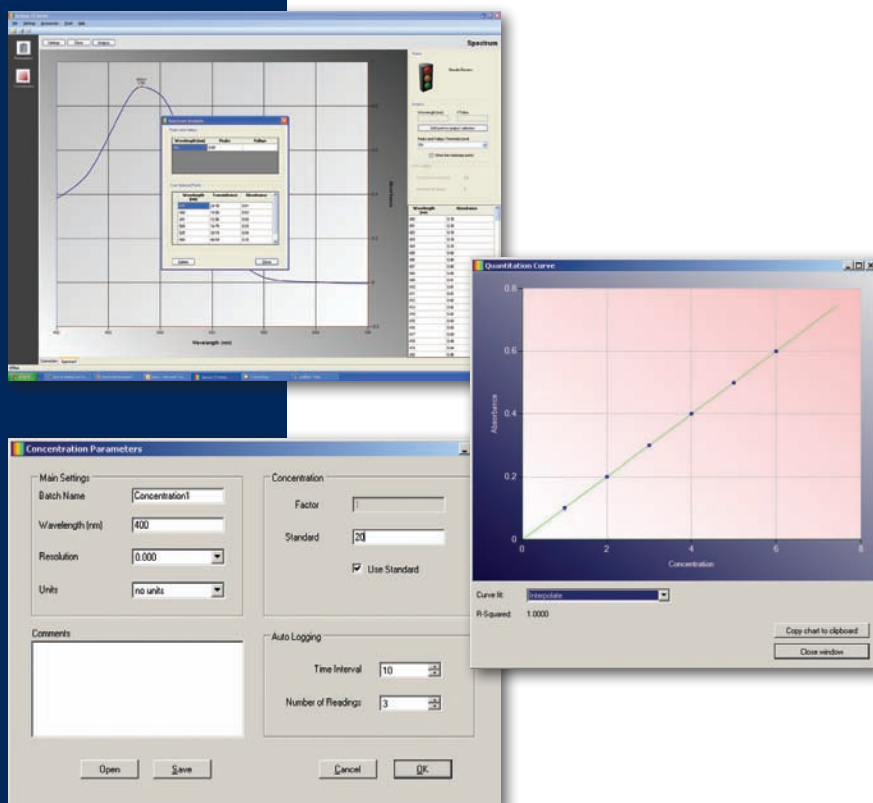

Software upgrades are available to download from www.jenway.com.

Bibby Scientific

Complementary products

Also available from Bibby Scientific

Bibby Scientific Ltd is one of the largest broad based manufacturers of laboratory products worldwide. Bibby Scientific Ltd provides internationally recognised brands with reputations for product quality and exceptional performance. These famous brands are now brought together in a single package to offer an excellent level of quality, service and support.

- Page 86** Stuart® Benchtop Science Equipment
- Page 87** Electrothermal® Equipment for all your heating, cooling and stirring needs
- Page 88** Techne® Equipment for the Life Sciences

Find out more! Please scan the QR/Mobile Tag with your smartphone for more information



Complementary products

Also available from Bibby Scientific...

Stuart® Equipment



Benchtop Science Equipment

The Stuart® range of benchtop science equipment includes block heaters, blood tube rotators, colony counters, hotplates, stirrers, rockers and shakers, rotary evaporators and water baths. Stuart® are also market leaders in melting point apparatus and water stills. The entire range is protected by BioCote® antimicrobial protection.



Block Heaters

Suitable for microbiology and clinical laboratories



Centrifuges

Mini centrifuge range



Colony Counter

Ideal for all microbiology applications



Homogenisers

Designed for the homogenisation of material



Hotplates and Stirrers

Available with metal or ceramic surfaces



Incubators

For accurate temperature controlled applications



Melting Point Apparatus

Determine high accuracy melting points



Mixers

For sample agitation within the laboratory



Rotary Evaporators

Commonly used for separating solvents



Rockers and Shakers

Available in orbital, linear, gyratory and see-saw actions



Water Baths and Purification

6, 15 and 24L capacity water baths

www.stuart-equipment.com



Complementary products

Also available from Bibby Scientific...

Techne® Equipment

Equipment for the Life Sciences

Techne is a long established name and world leader in the manufacture of temperature control and essential equipment for the life sciences, research, clinical and general laboratories. The Techne range of products encompasses temperature controlled water baths, Dri-Block® heaters, cell culture equipment and molecular biology products such as hybridisation incubators and thermal cyclers.



Baths and Thermoregulators

Allows precise temperature control



Biological Stirrers

Ideal for the growth of suspension cell culture



Dri-Block® Heaters

Compact constant temperature Dri-Block heating



Gelation Timers

Accurate measurement of gelation in the laboratory



Hybridisation Incubators

Ideal for blotting techniques



Sample Concentrators

Accelerates concentration of samples



Sample Cooling

Sample incubation under sub-ambient temperature



Thermal Cyclers

Compact, robust and versatile, the range includes models to suit every application and budget. All models feature Peltier technology, easily interchangeable blocks, intuitive user interfaces and networkable to a PC for ease of control and programming.

www.techne.com



Complementary products

Also available from Bibby Scientific...



Electrothermal® Equipment

Equipment for heating, cooling and stirring

Electrothermal are the newest addition to the Bibby Scientific portfolio and are market leaders in heating mantle design and manufacture. The extensive Electrothermal range includes controlled, stirring, Bunsen and spill-proof mantles in various shapes and capacities. Alongside the heating mantle range, Electrothermal offer an extensive selection of stirrers and melting point apparatus.



CMU Controlled Mantles

Chemical-resistant, lightweight and easy to clean



EM Heating Mantles

Maximum heat transfer with minimum risk



Extraction Heaters

Vented case's unique air flow ensures the case remains constantly cooled.



Heating Cords and Tapes

Offering tube insulation and protection.



Melting Points

Determine high accuracy melting points.



Kjeldahl Equipment

Equipment for the determination of nitrogen in organic and inorganic substances.



Controllers

Ideal for all heating mantles, mats and tapes.



Paraffin range

For use in pathology and histology applications.



STEM

STEM range includes reaction blocks and stations which are ideal for the measurement of reaction processes and parallel synthesis.

www.electrothermal.com





JENWAY

Technical Information

Equipment for Analysis

Jenway have a dedicated Technical Support team who are on hand to help with any applications advice and questions you may have about our products and how to use them. The team is made up of experienced laboratory scientists whose backgrounds include chemistry, biochemistry, cell and molecular biology. There are two fully equipped laboratories which are used for developing applications, testing new products and assisting with customer protocols.

Page 90	Service and Repair
Page 91	Certifications and Conformity
Page 92	Guide to Spectrophotometry
Page 94	Voltage Variants

Find out more! Please scan the QR/Mobile Tag with your smartphone for more information



Service and Repair

service@bibby-scientific.com

Our dedicated service staff are on hand to help in the unlikely event that your Jenway equipment develops a fault. Please contact them by one of the following means with a clear description of the problem:

E-mail: service@bibby-scientific.com

Tel: +44 (0) 1785 810475

Fax: +44 (0) 1785 810471

On occasion it may be necessary for your equipment to be sent back to our Service Department for repair. In this case please contact the Service Department for a reference number which you should include with your faulty equipment. Please also ensure you include a clear description of the fault and a completed copy of our Decontamination Certificate. This is available as a downloadable pdf file at www.jenway.com, or contact us and we will be happy to fax you a copy. Please clearly mark the package for the attention of the Service Department and post to the following address:

Service Department
Bibby Scientific Ltd
Beacon Road, Stone
Staffordshire, ST15 0SA

All replacement parts are guaranteed for 1 year and where ever possible, returned equipment is turned around in 5 working days. Please contact our Service Department for further information on onsite repairs and equipment calibration services.

Technical Support

jenwayhelp@bibby-scientific.com

Jenway have a dedicated Technical Support team who are on hand to help with any applications advice and questions you may have about our products and how to use them. The team is made up of experienced laboratory scientists whose backgrounds include chemistry, biochemistry, cell and molecular biology. There are two fully equipped laboratories which are used for developing applications, testing new products and assisting with customer protocols. We aim to respond to queries on the same day if at all possible. If you have any technical queries concerning any of our products you may call our dedicated Technical Support phone line or email us at the following address:

E-mail: jenwayhelp@bibby-scientific.com

Tel: +44 (0)1785 810433

Fax: +44 (0) 1785 810471



Declaration of Conformity

UV/Visible Spectrophotometer, Genova Plus

This product complies with the requirements of the EU Directives listed below:

2004/108/EC EMC Directive.
2006/95/EC Low voltage Directive (LVD)

Compliance with the requirements of these Directives is claimed by meeting the following standards:

EN 61326-1:2006 (Electrical Equipment for Measurement, Control and Laboratory use).
EN 61010-1:2001 (Safety Requirements Electrical Equipment for Measurement, Control and Laboratory use)

CE mark affixed '12

Signed:  (Mr S. Marriott)

Date: 4/1/2012

Authority: Technical Director
Bibby Scientific Ltd



Certificate of Registration

QUALITY MANAGEMENT SYSTEM - ISO 9001:2008

This is to certify that:

Bibby Scientific Ltd
Beacon Road
Stone
ST15 0SA
United Kingdom

Holds Certificate No: FM 537326
and operates a Quality Management System which complies with the requirements of ISO 9001:2008 for the following scope:

The design, manufacture and distribution of electronic and electrical science equipment to customer specifications.

For and on behalf of BSI:



Managing Director, BSI EMEA

Originally registered: 10/06/2008

Latest Issue: 06/04/2011

Expiry Date: 06/04/2014



Page: 1 of 1

This certificate was issued electronically and remains the property of BSI and is bound by the conditions of contract.
An electronic certificate can be authenticated [online](http://www.bsigroup.com/ClientDirectory).
Printed copies can be validated at www.bsigroup.com/ClientDirectory

The British Standards Institution is incorporated by Royal Charter.
BSI (UK) Headquarters: P.O. Box 9000, Milton Keynes MK14 6WT. Tel: 0845 080 9000



CE Conformity

Safety Standards

At Jenway we rigorously test our electrical products against the CE and safety standards in place. In addition, the majority of our products are independently tested by an accredited test house. This is reinforced by comprehensive technical and manufacturing data which is available for inspection upon request. Copies of the Conformity Certificates may be downloaded from our website www.jenway.com

WEEE & RoHS Regulations

Legislation and Regulations

The Waste Electrical and Electronic Equipment legislation ("the WEEE Regulations Directive 2002/96/EC") is now in force in the UK. The primary purpose of the WEEE directive is the prevention of waste electrical and electronic equipment, and to require the re-use, recycling and other forms of recovery as to reduce such waste disposal to landfill or incineration.

The restriction of the Use of Certain Hazardous Substances in Electrical and Electronic Equipment Regulations 2005 ("the RoHS Regulations Directive 2002/95/EC") have now been passed into UK legislation. The primary purpose of these regulations is to restrict the use of lead, mercury, cadmium, hexavalent chromium, polybrominated biphenyls (PBB) or polybrominated diphenyl ethers (PBDE) in new electrical and electronic equipment put on the market in the European Union after July 1, 2006. As a responsible manufacturer, Bibby Scientific will comply with such regulation as it affects our products and will continue to promote "clean" environmental manufacturing practices.

ISO9001:2008

Quality Assurance

The Jenway quality assurance system was first approved in 1992, and is currently certified to the International Quality Standard BS EN ISO 9001:2008. This means that Jenway is committed to providing the highest quality products, services and customer satisfaction.

The scope of our certificate No. FM537326 is: Marketing, design, manufacture and service of analytical and electrochemical instrumentation.

Further details of certification may be downloaded from our website: www.jenway.com

Selecting a Spectrophotometer

Visible or UV/Visible?

UV-Visible spectroscopy is the measurement of the absorbance at a specific wavelength by a sample within the UV or visible regions of the spectrum. It is one of the oldest analytical techniques and is used to identify the presence and concentration of many molecular entities. Therefore the first question to ask is whether a visible or UV/visible spectrophotometer is required? The near UV region is considered to be from 200 to 380 nm and the visible region from 380 to 800 nm. Jenway have extended the ranges of some of the visible and UV/visible spectrophotometers up to 1100 nm, which is considered to be in the NIR part of the spectrum.

Is scanning capability required?

Many applications require an option for spectrum scanning i.e. measuring the absorbance at each wavelength within a region of the spectrum. However some laboratories only require scanning to 'trouble shoot' the occasional problem. The cost of the instrument is significantly reduced if scanning is not required.

What types of sample are being measured?

The majority of samples in UV/visible spectroscopy are liquid which are usually measured in 10mm glass or quartz silica cuvettes depending upon the wavelength range required. Glass is only suitable for the visible region, whereas quartz can be used in both the UV and visible region. A 10mm cuvette typically holds 2 to 3ml of sample. However for applications such as DNA or protein assays where the amount of sample is limited Jenway offer micro cell holder accessories and micro cuvettes that allow the accurate measurement of volumes down to 50 μ l. With the TrayCell sample volumes as low as 2 μ l can be used. For extra sensitivity in sample measurement Jenway offer a range of long path cell holders up to 100mm.

Optics system: single beam or double beam?

Jenway spectrophotometers are available with single, split-beam or double beam optics. Single beam spectrophotometers are lower cost instruments, with the baseline to compensate for changes in lamp output intensity and blank absorbance being stored prior to taking the sample measurement. The instrument automatically compensates for the stored baseline when the sample is measured. In contrast double beam instruments record the sample and reference simultaneously, resulting in the instrument electronics compensating for the reference in real time. Double beam instruments tend to offer better stability in the UV region and are necessary when the blank or sample solutions are unstable or transient.

Which light source?

UV/visible spectrophotometers generally use two light sources to ensure the spectral irradiance is of sufficient intensity over the entire wavelength range. In these instruments the most common light sources used are tungsten halogen lamps for the visible range and deuterium lamps for the UV wavelengths, with a source selector to switch between the lamps. Jenway also offer a range of UV/visible and visible spectrophotometers that use a pulsed xenon lamp. The pulsed xenon lamp offers a good intensity continuum over both the UV and visible parts of the spectrum and has the added advantage of a much increased expected lifetime.

Is it a requirement to store methods and results?

To speed up the time taken for sample processing and to reduce user error, modern laboratories often have the requirement for spectrophotometers to save both methods and results. Jenway spectrophotometers offer a range of storage media from internal memory storage through to removable media such as SD cards.

Is it necessary to increase sample throughput?

In commercial laboratories the need to increase sample throughput and reduce sample handling leads to the need for automated sample introduction by using either a multi-cell changer or a sipper system. Multi-cell changers can be used in manual or automatic operation and are often used for enzyme kinetic assays. Sippers improve sample throughput by using a peristaltic pump to introduce precise volumes of sample into a flowcell.

Selecting a Spectrophotometer

Is sample temperature control required?

Some analyses such as enzyme kinetics require the absorbance change to be measured over time and often require the sample's temperature to be controlled electrically (peltier control) or by circulating water through the sample holder. Temperature control options are available for all Jenway spectrophotometers.

Does the spectrophotometer need to be connected to a PC?

Different measurements can require a differing degree of post-scan data manipulation. Jenway spectrophotometers offer a wide-range of post scan manipulation options and all can be connected to a PC.



Spectrophotometric Quantitation of Nucleic Acids

Spectrophotometric conversions

$A_{260} = 1$ (1cm detection path)	Concentration ($\mu\text{g/ml}$ water)
dsDNA	50
ssDNA	33
ssRNA	40
Oligonucleotide	20 - 30

Pure DNA has an A_{260}/A_{280} ratio of 1.8-2.0 in 10mM Tris-Cl, pH 8.5

Pure RNA has an A_{260}/A_{280} ratio of 1.9-2.1 in 10mM Tris-Cl, pH 7.5



Flame Photometry: Wavelengths of Elements

Spectrophotometric conversions

When sodium is introduced into a flame, it emits a radiation in the yellow region of the visible spectrum. The table below gives details of the measurable atomic flame emissions of the alkali and alkaline earth metals in terms of the emission wavelength and the colour produced.

Element	Emission Wavelength (nm)	Flame Colour
Barium (Ba)	554	Lime Green
Calcium (Ca)	622*	Orange
Lithium (Li)	670	Red
Potassium (K)	766	Violet
Sodium (Na)	589	Yellow

*Note: Calcium is measured by using the calcium hydroxide band emission at 622nm as the calcium main atomic emission occurs at 423nm.



Conductivity Meters

Voltage Variants

Part Code	Description
451 101	4510 conductivity meter supplied with glass conductivity probe with ATC (K=1) (027 013), electrode holder and US power supply
451 201	4510 conductivity meter supplied with glass conductivity probe with ATC (K=1) (027 013), electrode holder and EU power supply
451 301	4510 conductivity meter supplied with glass conductivity probe with ATC (K=1) (027 013), electrode holder and 230V leaded power supply
452 101	4520 conductivity meter supplied with glass conductivity probe with ATC (K=1) (027 013), electrode holder and US power supply
452 201	4520 conductivity meter supplied with glass conductivity probe with ATC (K=1) (027 013), electrode holder and EU power supply
452 301	4520 conductivity meter supplied with glass conductivity probe with ATC (K=1) (027 013), electrode holder and 230V leaded power supply
354 101	3540 conductivity/pH meter supplied with glass combination pH electrode (924 005), glass conductivity probe (K=1, 027 013), electrode stand and holder, ATC probe (027 500), BNC shorting plug, pH buffers and US power supply
354 201	3540 conductivity/pH meter supplied with glass combination pH electrode (924 005), glass conductivity probe (K=1, 027 013), electrode stand and holder, ATC probe (027 500), BNC shorting plug, pH buffers and EU power supply
354 301	3540 conductivity/pH meter supplied with glass combination pH electrode (924 005), glass conductivity probe (K=1, 027 013), electrode stand and holder, ATC probe (027 500), BNC shorting plug, pH buffers and 230V leaded power supply

Dissolved Oxygen Meters

Voltage Variants

Part Code	Description
950 101	9500 dissolved oxygen meter supplied with DO ₂ probe with ATC (522 023), electrode holder, spare membranes, KCl fill solution, zero calibration salts, adapter bush and US power supply
950 201	9500 dissolved oxygen meter supplied with DO ₂ probe with ATC (522 023), electrode holder, spare membranes, KCl fill solution, zero calibration salts, adapter bush and European power supply
950 301	9500 dissolved oxygen meter supplied with DO ₂ probe with ATC (522 023), electrode holder, spare membranes, KCl fill solution, zero calibration salts, adapter bush and 230V leaded power supply

Flame Photometers

Voltage Variants

Part Code	Description
500 731	PFP7 industrial flame photometer supplied with Na, K, Ba, Ca and Li filters, connecting hoses and clips, compressor plug and drain trap (110V/60Hz)
500 831	PFP7/C clinical flame photometer supplied with Na, K and Li filters, connecting hoses and clips, compressor plug and drain trap (110V/60Hz)
535 002	Air compressor (110V/60Hz)

Fluorimeters

Voltage Variants

Part Code	Description
632 031	Sipper pump, supplied with inlet and outlet tubing (110V/60Hz)

Ion Meters

Voltage Variants

Part Code	Description
548 101	3345 dual channel ion meter supplied with glass combination pH electrode (924 005), electrode stand electrode holder, BNC to S7 leadless connector (013 173) for connection to ISEs, ATC probe (027 232), buffer sachets and US power supply
548 201	3345 dual channel ion meter supplied with glass combination pH electrode (924 005), electrode stand electrode holder, BNC to S7 leadless connector (013 173) for connection to ISEs, ATC probe (027 232), buffer sachets and EU power supply
548 301	3345 dual channel ion meter supplied with glass combination pH electrode (924 005), electrode stand electrode holder, BNC to S7 leadless connector (013 173) for connection to ISEs, ATC probe (027 232), buffer sachets and 230V leaded power supply

pH Meters

Voltage Variants

Part Code	Description
351 101	3510 pH/mV meter supplied with glass combination pH electrode (924 005), electrode stand and holder, ATC probe (027 500), BNC shorting plug, pH 4, 7 and 10 buffers and US power supply
351 201	3510 pH/mV meter supplied with glass combination pH electrode (924 005), electrode stand and holder, ATC probe (027 500), BNC shorting plug, pH 4, 7 and 10 buffers and European power supply
351 301	3510 pH/mV meter supplied with glass combination pH electrode (924 005), electrode stand and holder, ATC probe (027 500), BNC shorting plug, pH 4, 7 and 10 buffers and 230V leaded power supply
352 101	3520 pH/mV meter supplied with glass combination pH electrode (924 005), electrode stand and holder, ATC probe (027 500), BNC shorting plug, pH 4, 7 and 10 buffer sachets and US power supply
352 201	3520 pH/mV meter supplied with glass combination pH electrode (924 005), electrode stand and holder, ATC probe (027 500), BNC shorting plug, pH 4, 7 and 10 buffer sachets and European power supply
352 301	3520 pH/mV meter supplied with glass combination pH electrode (924 005), electrode stand and holder, ATC probe (027 500), BNC shorting plug, pH 4, 7 and 10 buffer sachets and 230V leaded power supply
354 101	3540 conductivity/pH meter supplied with glass combination pH electrode (924 005), glass conductivity probe (K=1, 027 013), electrode stand and holder, ATC probe (027 500), BNC shorting plug, pH buffers and US power supply
354 201	3540 conductivity/pH meter supplied with glass combination pH electrode (924 005), glass conductivity probe (K=1, 027 013), electrode stand and holder, ATC probe (027 500), BNC shorting plug, pH buffers and EU power supply
354 301	3540 conductivity/pH meter supplied with glass combination pH electrode (924 005), glass conductivity probe (K=1, 027 013), electrode stand and holder, ATC probe (027 500), BNC shorting plug, pH buffers and 230V leaded power supply

Spectrophotometers

Voltage Variants

Part Code	Description
630 531	6300 visible spectrophotometer supplied with mains lead, pack 100 disposable cuvettes, 10 x 10mm cell holder, interface cable and PC application software on CD-ROM (110V/60Hz)
632 521	6320D visible spectrophotometer supplied with mains lead and dual cell holder (for 10mm square cuvettes and 12.7mm diameter tubes) (110V/60Hz)
635 031	6305 UV/visible spectrophotometer supplied with mains lead, pack 100 disposable cuvettes, 10 x 10mm cell holder, interface cable and PC application software on CD-ROM (110V/60Hz)
636 035	Genova UV/visible life sciences spectrophotometer supplied with TrayCell, mains lead, 8 x 750µl UV plastic cuvettes and cell holder (110V/60Hz)
632 031	Sipper pump, supplied with inlet and outlet tubing (110V/60Hz)
543 201	40 column printer supplied with interface cable, paper roll (060 287) and ribbon (060 288) and EU power adapter
543 501	40 column printer supplied with interface cable, paper roll (060 287) and ribbon (060 288) and US adapter

Description	Page Number
Colorimeter	6
Colorimeter Accessories	7
Cells & Cuvettes	7
Conductivity Meters	10, 11 - 16
Bench Conductivity Meters	10, 12, 13
Bench Conductivity/ pH Meters	10, 15, 42, 50
Portable Conductivity Meters	10, 11
Portable Conductivity/pH Meters	10, 14, 42, 49
Conductivity Accessories	16, 17
Conductivity Cells	16
Printers & PC Software	17
Standards & Buffers	17
Dissolved Oxygen Meters	20, 21 - 24
Bench DO2	20, 22
Portable DO2	20, 21
Dissolved Oxygen Meter Accessories	23, 24
B.O.D Accessories	23
Consumables	24
Printers & PC Software	24
Probe Accessories	23
Probes	23
Flame Photometers	26 - 28
Clinical Flame Photometer	27
Industrial Flame Photometer	26
Flame Photometer Accessories	28
Clinical Standards	28
Industrial Standards	28
Fluorimeters	30 - 34
62 Series Fluorimeters	30, 31
Fluorimeters Accessories	32 - 34
Cuvettes	34
Filters	32
Heated Cell System	33
Interference Filters	32
PC Software	34
Printers	34
Sipper Pump	33
Ion Meters	36 - 40
Bench Ion Meters	37
Portable Ion/pH Meters	36, 42, 45
Ion Meter Accessories	38 - 40
Ion Selective Electrode Consumables	40

Index

Index by Name

Bold numbers represent comparison charts

Description	Page Number
Ion Selective Electrode Kits	40
Ion Selective Electrodes	39
Printers	38
Reference Electrodes for Mono ISEs	39
Temperature Probes and Connectors	38
pH Meters	42 - 56
Bench Conductivity/ pH Meter	10, 15, 42, 50
Bench pH	42, 46, 48
Bench pH/mV Meter	42, 47
Portable Conductivity/pH Meter	10, 14, 42, 49
Portable Ion/pH Meter	36, 42, 45
Portable pH Meter	42, 43
Portable pH/mV Meter	42, 44
pH Meter Accessories	51 - 55, 56
Buffers & Solutions	55
pH Electrodes	51 - 54, 56
Application Specific	52
Combination	52
Performance	51
Waterproof	53
Spectrophotometers	58 - 84
UV/Visible	58, 59, 61, 65, 67 - 71, 74, 75, 78, 79
Visible	58, 59, 60, 64, 66,
Double Beam	58, 59, 78, 79
Single Beam	58, 59, 60, 61, 64 - 71
Split Beam	58, 59, 74, 75
General Spectrophotometer Accessories	80 - 83
Disposable Cuvettes	80
Glass Cuvettes	80
Flow Cells	81
Quartz Cuvettes	81
TrayCell	82
Environmental Test Kits	83
Environmental Test Kit Vials	83
63 Series	58, 59, 60 - 63
6300 & 6320D Visible Spectrophotometers	58, 59, 60
6305 UV/Visible Spectrophotometers	58, 59, 61
63 Series Accessories	62, 63
Cuvette Holders	62
Printers	62
Sipper Pump	63
73 Series	58, 59, 64 - 73
7300 Visible Spectrophotometer	58, 59, 64
7305 UV/Visible Spectrophotometer	58, 59, 65

Description	Page Number
7310 Visible Scanning Spectrophotometer	58, 59, 66
7315 UV/Visible Scanning Spectrophotometer	58, 59, 67
Genova Plus	58, 59, 68, 69
Genova Nano	58, 59, 70, 71
73 Series Accessories	72, 73
Active	72, 73
Automatic 8 Position Cuvette Holder	72, 73
Combined Sipper Peltier	72, 73
Sipper Pump	72, 73
Temperature Control	72, 73
Passive	73
Cuvette Holders	73
Printer	73
67 Series	58, 59, 74 - 77
6700 Visible Scanning Spectrophotometer	58, 59, 74, 75
6705 UV/Visible Scanning Spectrophotometer	58, 59, 74, 75
6715 UV/Visible Scanning Spectrophotometer	58, 59, 74, 75
67 Series Accessories	76, 77
Cell Holders	76, 77
Heated Cell & Sipper Pump	76, 77
Printers	77
6850 Series	58, 59, 78, 79
6850 UV/Visible Double Beam Spectrophotometer	58, 59, 78, 79
6850 Series Accessories	78
Voltage Variants	94 - 96
Conductivity Meters	94
Dissolved Oxygen Meters	94
Flame Photometers	95
Fluorimeters	95
Ion Meters	95
pH Meters	96
Spectrophotometers	96

Index

Index by Part Code

Bold numbers represent comparison charts

<u>Part Code</u>	<u>Page Number</u>	<u>Part Code</u>	<u>Page Number</u>	<u>Part Code</u>	<u>Page Number</u>
012 075	63	025 092	40	025 165	17
012 075	73	025 093	40	025 167	40
012 075	77	025 094	40	025 169	40
012 094	63	025 095	40	025 171	28
012 146	73, 77	025 096	40	025 179	55
013 161	38	025 097	40	025 180	55
013 173	38	025 098	40	025 181	55
019 133	77	025 099	40	025 192	55
019 146	73	025 100	40	025 196	55
021 007	17	025 101	40	025 197	55
021 007	24	025 106	40	025 300	83
021 007	55	025 107	40	025 301	83
021 008	55	025 118	40	025 302	83
021 030	46	025 120	40	025 303	83
021 146	34	025 122	40	025 304	83
025 004	28	025 126	40	025 305	83
025 005	28	025 127	40	025 306	83
025 006	28	025 128	40	025 307	83
025 007	28	025 129	40	025 308	83
025 008	28	025 130	40	025 309	83
025 009	28	025 132	40	025 310	83
025 021	28	025 134	40	025 311	83
025 023	28	025 136	40	025 312	83
025 024	28	025 138	17	025 313	83
025 025	28	025 139	17	025 314	83
025 027	28	025 142	40	025 315	83
025 037	55	025 143	40	025 316	83
025 038	55	025 144	40	025 317	83
025 039	55	025 145	40	025 318	83
025 051	40	025 146	40	025 320	83
025 053	40	025 147	40	025 321	83
025 055	40	025 148	40	025 322	83
025 057	40	025 149	40	025 323	83
025 059	40	025 150	40	025 324	83
025 061	40	025 151	40	025 325	83
025 063	40	025 152	40	025 326	83
025 065	40	025 156	17	025 327	83
025 067	40	025 157	17	025 328	83
025 069	40	025 157	55	025 329	83
025 071	40	025 158	17	025 330	83
025 073	40	025 158	55	025 331	83
025 075	40	025 159	17	025 332	83
025 085	40	025 159	55	025 333	83
025 087	40	025 160	55	025 334	83
025 088	40	025 161	55	025 335	83
025 089	40	025 162	55	025 336	83
025 090	40	025 163	55	025 337	83
025 091	40	025 164	17	025 338	83

Bold numbers represent comparison charts

Index by Part Code

Part Code	Page Number	Part Code	Page Number	Part Code	Page Number
027 013	16	035 143	80	351 101	96
027 113	16	035 262	82	351 201	96
027 211	16	035 263	82	351 301	96
027 212	16	035 264	82	352 001	42, 48
027 213	16	035 281	81	352 101	96
027 227	53, 56	035 282	81	352 201	96
027 232	38	037 551	17	352 301	96
027 298	16	037 551	34	354 001	10, 15
027 500	54	037 551	54	354 001	42, 50
027 502	16	037 551	62	354 101	94
027 502	54	037 701	17	354 101	96
027 801	16	037 701	24	354 201	94
027 802	16	037 701	34	354 201	96
027 900	16	037 701	54	354 301	94
028 200	33	037 702	24	354 301	96
033 162	55	037 702	34	370 271	42, 44
033 267	55	037 702	54	430 231	16
033 268	17	037 702	77	430 271	10, 14
033 268	55	037 801	17	430 271	42, 49
033 269	17	037 801	54	451 001	10, 12
033 270	24	050 501	17	451 101	94
033 290	34	050 501	24	451 201	94
033 290	63	050 501	34	451 301	94
035 027	7	050 501	54	452 001	10, 13
035 027	80	060 084	7	452 101	94
035 028	81	060 084	80	452 201	94
035 029	7	060 087	7	452 301	94
035 029	80	060 087	80	470 271	10, 11
035 030	81	060 229	80	500 019	28
035 044	81	060 230	80	500 093	28
035 045	81	060 231	80	500 134	28
035 047	81	060 232	80	500 172	28
035 056	81	060 247	34	500 176	28
035 079	80	060 253	34	500 177	28
035 086	7	060 254	34	500 178	28
035 086	80	060 255	34	500 179	28
035 087	80	060 287	38	500 180	28
035 088	77	060 287	62	500 701	26
035 091	77	060 288	38	500 731	95
035 120	34	060 288	62	500 801	27
035 121	34	060 406	17	500 831	95
035 122	34	060 406	24	522 019B	23
035 123	80	060 406	55	522 023B	23
035 124	81	060 422	7	522 050B	23
035 125	81	060 422	77	535 001	28
035 126	80	350 271	42, 43	535 002	28
035 127	81	350 501	42, 46	535 002	95
035 138	81	351 001	42, 47	538 014	53

Index

Index by Part Code

Bold numbers represent comparison charts

<u>Part Code</u>	<u>Page Number</u>	<u>Part Code</u>	<u>Page Number</u>	<u>Part Code</u>	<u>Page Number</u>
539 501	36	627 151	32	628 501	31
539 501	42, 45	627 152	32	630 005	62
541 520B	23	627 153	32	630 005	73
541 553	24	627 154	32	630 005	77
542 009	62	627 155	32	630 028	34
543 001	38	627 156	32	630 028	63
543 001	62	627 157	32	630 204	62
543 201	96	627 158	32	630 204	73
543 501	96	627 159	32	630 204	77
544 008	38	627 160	32	630 304	62
548 001	37	627 161	32	630 304	73
548 101	95	627 162	32	630 304	77
548 201	95	627 163	32	630 501	58, 59, 60
548 301	95	627 164	32	630 531	96
552 050	23	627 165	32	632 001	33
605 001	6	627 166	32	632 001	63
605 003	7	627 167	32	632 031	33
605 064	7	627 168	32	632 031	63
606 017	7	627 169	32	632 031	95
606 018	7	627 170	32	632 031	96
627 001	31	627 171	32	632 501	60
627 124	32	627 172	32	632 511	62
627 125	32	627 173	32	632 521	96
627 126	32	627 174	32	634 001	62
627 127	32	627 175	32	635 001	58, 59, 61
627 128	32	627 176	32	635 031	96
627 129	32	627 177	32	636 024	62
627 130	32	627 178	32	636 035	96
627 131	32	627 179	32	637 071	62
627 132	32	627 180	32	637 071	73
627 133	32	627 181	32	637 071	77
627 134	32	627 182	32	648 001	62
627 135	32	627 183	32	648 001	77
627 136	32	627 184	32	660 001	77
627 137	32	627 185	32	660 101	73
627 138	32	627 186	32	660 101	77
627 139	32	627 187	32	660 201	76, 77
627 140	32	627 188	32	660 301	76, 77
627 141	32	627 189	32	660 401	76, 77
627 142	32	627 190	32	660 403	77
627 143	32	627 191	32	660 501	76, 77
627 144	32	627 192	32	660 503	76, 77
627 145	32	627 193	32	660 701	76, 77
627 146	32	627 194	32	661 201	77
627 147	32	627 195	32	670 0B0	58, 59, 75
627 148	32	627 196	32	670 5B0	58, 59, 75
627 149	32	627 197	32	671 5B0	58, 59, 75
627 150	32	628 001	31	685 005	78

Bold numbers represent comparison charts

Index by Part Code

Part Code	Page Number	Part Code	Page Number	Part Code	Page Number
685 131	78	924 056	53	924 510	39
685 204	78	924 067	16, 56	924 511	39
685 304	78	924 067	52	924 512	39
685 401	78	924 068	52	924 513	39
685-SC	58, 59, 78, 79	924 069	52	924 515	39
730 001	58, 59, 64	924 070	52, 56	924 516	39
730 501	58, 59, 65	924 076	52, 56	924 517	39
731 001	58, 59, 66	924 077	52, 56	924 518	39
731 501	58, 59, 67	924 078	52, 56	924 519	39
735 001	73	924 079	52, 56	924 521	39
735 201	72, 73	924 080	52, 56	924 523	39
735 301	72, 73	924 300	39	924 904	51
735 401	72, 73	924 301	39	924 905	51
735 601	73	924 302	39	950 001	20, 22
735 701	72, 73	924 304	39	950 101	94
736 201	72, 73	924 305	39	950 201	94
736 501	58, 68,69	924 307	39	950 301	94
737 501	58, 70,71	924 308	39	970 231B	23
903 300	17	924 309	39	970 271	20, 21
903 300	24	924 311	39	983 030	24
903 300	38	924 313	39		
903 300	55	924 314	39		
924 001	52, 56	924 316	39		
924 002	52, 56	924 317	39		
924 003	52, 56	924 318	39		
924 005	52, 56	924 321	39		
924 007	52, 56	924 322	39		
924 010	52, 56	924 323	39		
924 015	52, 56	924 324	39		
924 016	39	924 325	39		
924 016	39	924 327	39		
924 016	54	924 328	39		
924 017	39	924 329	39		
924 017	39	924 400	40		
924 017	54	924 401	40		
924 030	52, 56	924 402	40		
924 034	52, 56	924 404	40		
924 035	52	924 405	40		
924 036	39	924 500	39		
924 036	54	924 501	39		
924 047	52, 56	924 502	39		
924 049	52, 56	924 503	39		
924 050	52, 56	924 504	39		
924 051	52, 56	924 505	39		
924 052	53, 56	924 506	39		
924 053	53	924 507	39		
924 054	53	924 508	39		
924 055	53	924 509	39		

JENWAY

A Bibby Scientific Company

Bibby Scientific - UK

Beacon Road, Stone,
Staffordshire,
ST15 0SA,
United Kingdom

T: +44 (0)1785 812121

F: +44 (0)1785 813748

E: sales@bibby-scientific.com

pH Meters

Probes and Electrodes

UV/Visible Spectrophotometers

Life Science Spectrophotometers

Double Beam Spectrophotometers



Find out more!!!

Please scan the QR/Mobile Tag with your smartphone for more information

www.jenway.com

Bibby Scientific

www.bibby-scientific.com

